



SELECTION  
Bathroom 



**Holistic lighting concepts**  
Perfect bathroom lighting



## Paulmann – a family business creating lighting ideas for 45 years

Paulmann Licht GmbH was founded in 1978 and is a leading brand manufacturer in the lighting industry. True to our motto "Realise your lighting ideas", we offer our customers high-quality light to make them feel good, and with high energy efficiency – both indoors and outdoors.

We are a German family business based in Springe, Lower Saxony, employing 450 people worldwide and distributing in over 40 countries in Europe. As a member of the UN Global Compact network, we attach great importance to sustainable business practices, environmental protection and social commitment. We are pursuing a programme to reduce the carbon footprint of our sites and products.

Our complete range features over 2,500 luminaires and lamps, for versatile packages with excellent value for money for every application. In particular, the system solutions for 1-phase and 3-phase light rails, recessed luminaires and panels, bathroom luminaires, profile strips and profiles as well as the 24 V "Plug & Shine" plug-in system for outdoor areas enable you as a planner and craftsman to optimally implement the individual wishes of your customers – including Zigbee

luminaires and components for smart control. We are a DIALux premium partner, which means that you benefit from additional planning security and can offer solutions tailored to your customers.

Our in-house designers, constructors and electronics engineers bring together technology, design and user benefits during product development and ensure the high-quality for which Paulmann is rightly famous.

Each of our products is accompanied by Paulmann product experts from the initial idea through to development, manufacture and final delivery. All our items and components are regularly checked by our own in-house Quality Assurance, as well as by external certified test laboratories. That's why we give a 5-year warranty on our Paulmann luminaires and transformers.

Our customers know that they can count on our extensive range and our excellent service: from product to logistics, service to content creation and product presentation.

For this reason, more than 20,000 trade customers throughout Europe rely on Paulmann for their lighting needs:

- Quick and reliable delivery
- High availability of goods
- Goods delivered within 48 hours for customers in Germany and within 72 hours throughout Europe
- Deliveries from quantities of 1
- Low freight-free threshold
- Standardised product data in ETIM format
- Options via EDIFACT: orders, order confirmations, delivery notes, invoices
- Paulmann Academy provides up-to-date product information online
- Expert service team

## Contents

Holistic bathroom lighting concepts	6
Bathroom lighting applications	10
Overview of recommended lighting applications	10
Controlling white light colours: For customised bathroom lighting solutions	12
Water and electricity	13
Luminaire series for the bathroom	14
Gove luminaire series	17
Luena luminaire series	27
Wall and ceiling luminaires	32
Recessed panels	46
Pendant luminaires	48
Spot series	50
Recessed luminaires	56
Illuminated mirrors	74
Mirror luminaires	82
Wall and mirror luminaire	86
Wall luminaires	100
LED strips	104
Key	110



## Sustainability at Paulmann

Social responsibility, environmental protection and sustainable corporate management play an important role in the Paulmann family business. We have integrated a holistic sustainability strategy into our corporate strategy, which equally includes ecological, economic and social aspects. In this way, we are actively committed to achieving the Sustainable Development Goals (SDGs). We are constantly revising the way we use light and developing lamps and luminaires that enable the economical use of energy and resources. But sustainability at Paulmann doesn't stop with the development and production of our products! At the same time, we are continuing to develop Paulmann's role as a company, and our influence on the three pillars of sustainability.



### Social commitment in the region

At Paulmann, we are a family – and this is reflected in the DNA of the family business. Providing equal opportunities and working for the common good are values that are deeply embedded in our culture. We work together to put the health and satisfaction of our employees and customers first.

Our goal is to actively take responsibility for our community and to set a positive example. That is why Paulmann has been supporting various local aid organisations and projects for children and young people in our region.



FSC®-certified products contribute to sustainable forestry around the world. The certification ensures that wood-based raw materials for our products come from sustainable and responsible sources only.



Shipping packaging consists of 100% recycled material. Cardboard already accounts for over 90% of product packaging. As of 2023, all new products – where possible – will be packaged completely without plastic.

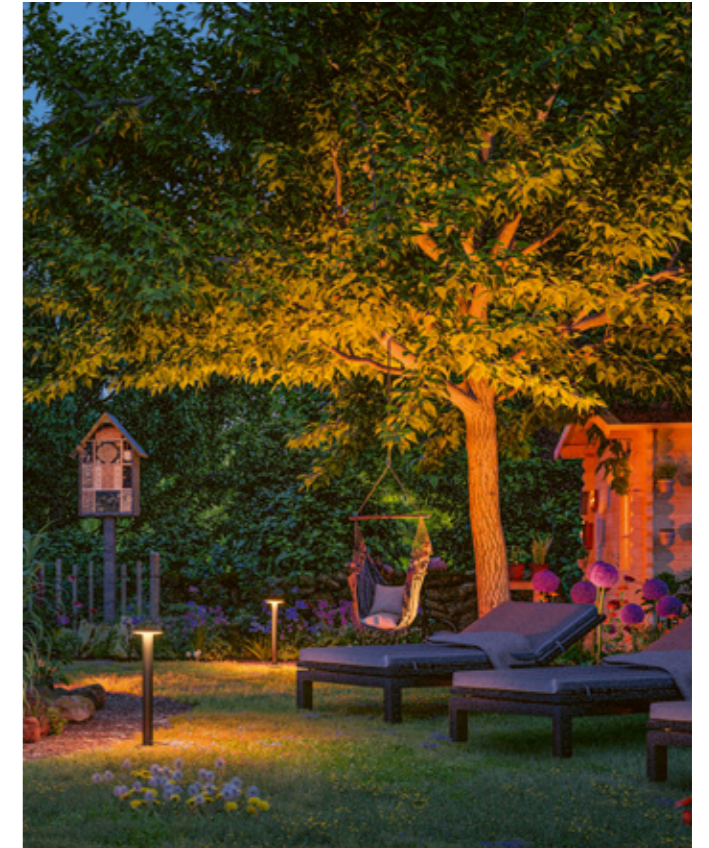

The insect-friendly outdoor luminaire range with 2200 K gold light provides safety and atmosphere while attracting hardly any insects, thus protecting biodiversity.

### Ecology – focussing on CO2 reduction

From green electricity and recycling to optimising our sales packaging and shipping processes: step by step, we at Paulmann are working to reduce our CO2 footprint as much as possible.

We want to consistently reduce our emissions and are constantly pursuing our numerous reduction measures – ideally until we achieve net zero emissions. To achieve this, we are focussing our resources and investments on measuring, analysing, avoiding and reducing our emissions. In order to constantly identify further improvements, we calculate our CCF – Corporate Carbon Footprint – annually in accordance with the Greenhouse Gas Protocol. We also aim to support the region where Paulmann has its roots, and so we invest in regional projects and the expansion of our company-wide reduction measures. For example:

- We use green electricity from 100% renewable energy at the company headquarters in Völkzen.
- We are installing e-charging stations and gradually converting our vehicle fleet to e-mobility.
- We are currently planning to build a photovoltaic system at our company headquarters.
- We are constantly optimising our shipping process by saving material and increasing the proportion of recycled material.

### Economy and governance – with responsibility and sustainability

We are convinced that responsible and long-term business activities can only be achieved by adhering to fair business practices. Sustainable business operations with high-quality materials, fair wages, career building opportunities for employees, training courses and apprenticeships for the next generation of employees, as well as investment to strengthen the overall business model are just as important for ensuring a holistic sustainability strategy. Paulmann has its roots in the region, and is known as a stable employer. In addition, Paulmann offers a range of apprenticeships, ensuring well-qualified junior staff.

Paulmann wants to systematically create maximum transparency in the supply chain, in accordance with the requirements of the German Supply Chain Act.



As a member of the UN Global Compact, Paulmann publishes an annual progress report on the achievement of the Sustainable Development Goals.

## Holistic bathroom lighting concepts

Paulmann offers a complete range for bathrooms with high-quality products at attractive prices.

At the heart of the range are timeless, modern and elegant design series for domestic bathrooms, as well as for bathroom applications in the commercial sector.

All items have at least IP44 protection, making them ideal for use in the bathroom.

The breadth of the range enables you to meet all your customers' lighting needs with Paulmann as your supplier.

Our products are marketed in series, which means that you can be confident in project consulting, as you can offer your customers a range of luminaires in a uniform design style.



### Quality and durability

Our bathroom luminaires feature impressive quality and a long service life.

The high-quality materials ensure that luminaires still look like new and retain their functionality even after many years. We offer a 5-year warranty on all bathroom luminaires.

The classic, timeless look of our luminaire designs suits any bathroom style and can be perfectly integrated into any setting.

The exceptional value for money makes the luminaires an indispensable solution for all those who are looking for long-lasting and stylish lighting for their bathroom.

## Health and safety

Our bathroom luminaires not only offer optimal lighting for bathrooms, but also numerous health and safety benefits.

Our products are exceptionally safe, thanks to the optimal levels of IP protection for preventing water penetration in the appropriate protection zones.

Paulmann represents maximum safety. All items comply with the specified European standards. Paulmann items are tested by VDE, TÜV or Paulmann Quality Assurance, even if a safety test is not mandatory.

Optimal illumination in different areas of the bathroom can prevent or reduce accidents. The right lighting improves visibility, such as for danger sources like water on the floor.

Our products with WhiteSwitch or Tunable White technology also support your circadian rhythms with suitable bathroom lighting, and can be adapted to your biorhythms thanks to white light control.

## Light characteristics

Our bathroom luminaires offer optimal lighting for every area of your bathroom. With a high lumen output and good colour rendering properties (CRI: Ra > 80), they provide a natural appearance and good illumination for many activities.

Whether applying make-up, shaving or simply relaxing – our luminaires are the perfect choice for any bathroom.





# Bathroom lighting applications

Optimal bathroom lighting is made up of three different lighting categories: Good general and basic lighting, combined with functional lighting for specific activities, and supplemented by atmospheric accent lighting.

Thanks to the harmonious overall effect, the bathroom becomes a place of rest and relaxation.

## Overview of recommended lighting applications

Installation site	General and basic lighting	Functional lighting	Accent lighting
Ceiling	Wall / ceiling luminaires Panels Spots Recessed luminaires Pendant luminaires	Wall luminaires Panels Recessed luminaires	Pendant luminaires LED strips
Wall	Wall / ceiling luminaires Panels	Wall luminaires Recessed wall luminaires	LED strips Wall luminaires Recessed wall luminaires Spots
Mirror	Mirror luminaires Wall luminaires Illuminated mirrors	Mirror luminaires Mirror clip luminaires Make-up / shaving mirror Illuminated mirrors	Wall luminaires
Interior design / furnishings		LED strips	LED strips



## General and basic lighting

General lighting provided by ceiling and wall luminaires or recessed luminaires creates a bright ambience in the bathroom.

This is essential for orientation and safety. High colour rendering and high lumen output ensure very good basic brightness. Some of the luminaires are dimmable and available with white light control.

## Functional lighting

Functional lighting can help with your daily bathroom routine. This includes ceiling and wall luminaires, recessed luminaires, mirror luminaires and luminaires with white-tone control, so that your bathroom has the perfect lighting to support your normal circadian rhythms. The light is not only functional, but can also have an invigorating, supporting or relaxing effect depending on the colour temperature, to give you the perfect lighting for all your bathroom routines. This creates just the right atmosphere for the bathroom at all times.

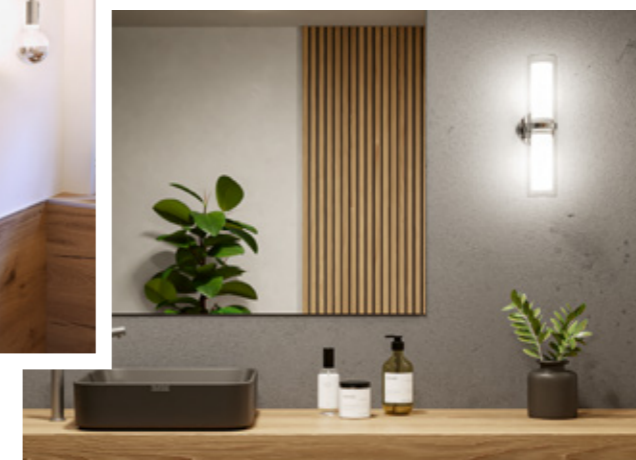
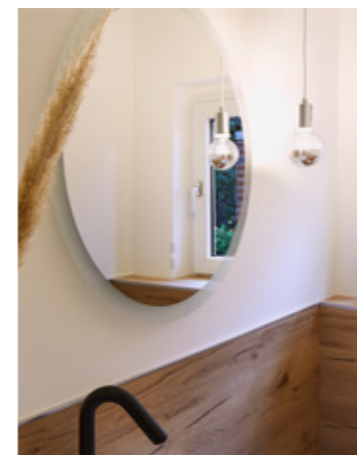

## Accent lighting

Creating accent lighting in the bathroom is so easy, with pendant luminaires or LED strips. But you can also use mirror luminaires, wall luminaires or spots for special lighting effects.

With the right insert, you can create varied and eye-catching bathroom lighting. Lighting or backlighting certain areas in the bathroom makes the room appear intriguing and attractive.



## Controlling white light colours: For customised bathroom lighting solutions

Changes in the intensity and colour temperature of sunlight throughout the day affect the human biological clock. Dimmed warm light, neutral light or bright daylight are all ideal for people at different times of day, and for different activities.

Luminaires with variable white tones help to harmonise artificially generated light with our natural rhythms. This has a positive effect on our health and well-being.

Daylight white light has an invigorating effect and is ideal for cleaning activities such as brushing your teeth or cleaning the bathroom. Neutral light is friendly and ideal for basic body care like shaving, make-up and showering.

Warm light has a calming effect, creating soothing vibes for bathing or relaxation. When you wake up, warm light provides a tranquil start to the day, and in the evening it creates a peaceful mood for winding down.



The **Tunable White** function in luminaires lets you choose any white light colour from warm white (2700 K) for relaxing, to daylight white (6500 K) for better concentration.



With the **White Switch** function, the tones of the white light colour can be easily selected in several (two to three) steps using a wall switch – from warm white (2700 K) to neutral white (4000 K) to daylight white (6500 K).



Zone 0 = IP67    Zone 1 = IP65    Zone 2 = IP44

## Water and electricity

### What to look out for when installing bathroom lighting

Humidity and electricity meet in the bathroom. This means that it is important to take certain precautions when installing luminaires. It is necessary to consider the IP protection of your bathroom luminaires. The IP protection indicates how well a luminaire is protected against the ingress of water. The IP protection class required depends on the position of the luminaire. Three protection areas are differentiated by zones:

**Zone 0:** Luminaires installed near the bathtub or shower must have an IP protection class of IP67. This means they are waterproof for temporary submersion. The luminaires may be operated with a maximum operating voltage of 12 volts AC or 30 volts DC. The transformer must be located outside the protection zones 0 and 1.

**Zone 1:** IP65 is the right protection class for bathroom luminaires on surfaces around the shower head, bathtub or shower trays that are installed up to a height of 2.25 m. These luminaires can withstand jets of water. The operating voltage must not exceed 26 volts AC or 60 volts DC and the transformer must be outside protection zones 0 and 1.

**Zone 2:** Luminaires with IP44 protection class are required for walls up to 2.25 m high and at a distance of up to 60 cm around the bath tub or shower, to ensure they are protected against splash water.

Outside these protection zones, luminaires do not need to have a higher IP protection rating.

## Luminaire series for the bathroom

The ideal bathroom lighting is composed of several light sources that harmonise with each other.

Design series offer your customers the perfect way to put together matching luminaires for the different areas of application in the bathroom, or in hotels, restaurants or shops.

Paulmann offers classically elegant design series reinterpreted for a very broad range of buyers.

The timeless design of the series will look good for many years, making them suitable for the long renovation cycles in bathrooms.

Other design series feature modern interpretations to fit into the ambience of modern hotels, restaurants or shops.







### Gove luminaire series

#### Timelessly elegant and classic bathroom luminaire globes

Whether classic glossy chrome or modern matt black, this series can be used in any private bathroom, as well as in the commercial sector. Gove creates perfect lighting accents in every bathroom with the ideal interplay of lighting and design. High-quality metal paired with matt opal glass and protection against water ingress (IP44) guarantee they will last a long time. The different types of wall, ceiling, and mirror luminaires, as well as pendant luminaires, complement each other perfectly and create a coordinated overall design with different lamps.

The luminaires from the Gove series are equipped either with the latest warm white LED technology or can be fitted with replaceable lamps for individual lighting designs. The glass elements can easily be removed without tools, featuring a bayonet lock for changing the lamp or cleaning. Spare glasses can be ordered for all luminaires.



1



2



3



Replaceable lamp | Recommended lamp 28796

chrome, satin | glass, metal | 230V

IP44

Bayonet glass

Spare glass 80 mm 60411

Dimmable

Gove	Watt	Base	Dimensions	Item
1 Wall and ceiling luminaire	max. 20W	G9	106 ø 80 mm	71061
2 Ceiling luminaire	max. 3x 20W	G9	100 ø 220 mm	71062
3 Wall and ceiling luminaire	max. 3x 20W	G9	100 400 80 mm	71063



1

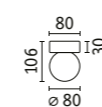

2

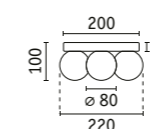

3

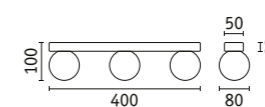



💡 Non-replaceable LED

📏 | 🌟 chrome, satin | 🏠 glass, metal | 230V

🛡️ IP44

🟡 warm white

🔄 Spare glass 120 mm 60413

🔄 Spare glass 170 mm 60414

Gove	Lumen	Watt	Kelvin	Dimensions	Item
1 Wall and ceiling luminaire	400 lm	5 W	3000 K	⌀160 ⌀120 mm	71064
2 Wall and ceiling luminaire	900 lm	9 W	3000 K	⌀215 ⌀170 mm	71065
3 Pendant luminaire	900 lm	9 W	3000 K	⌀1500 ⌀170 mm	71066
4 Wall luminaire	400 lm	5 W	3000 K	⌀185 ⌀120 ↗150 mm	71067

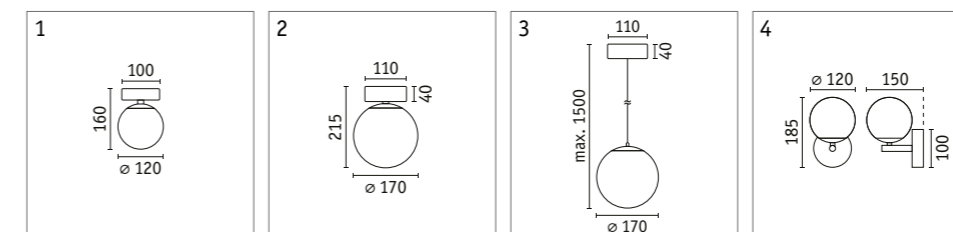

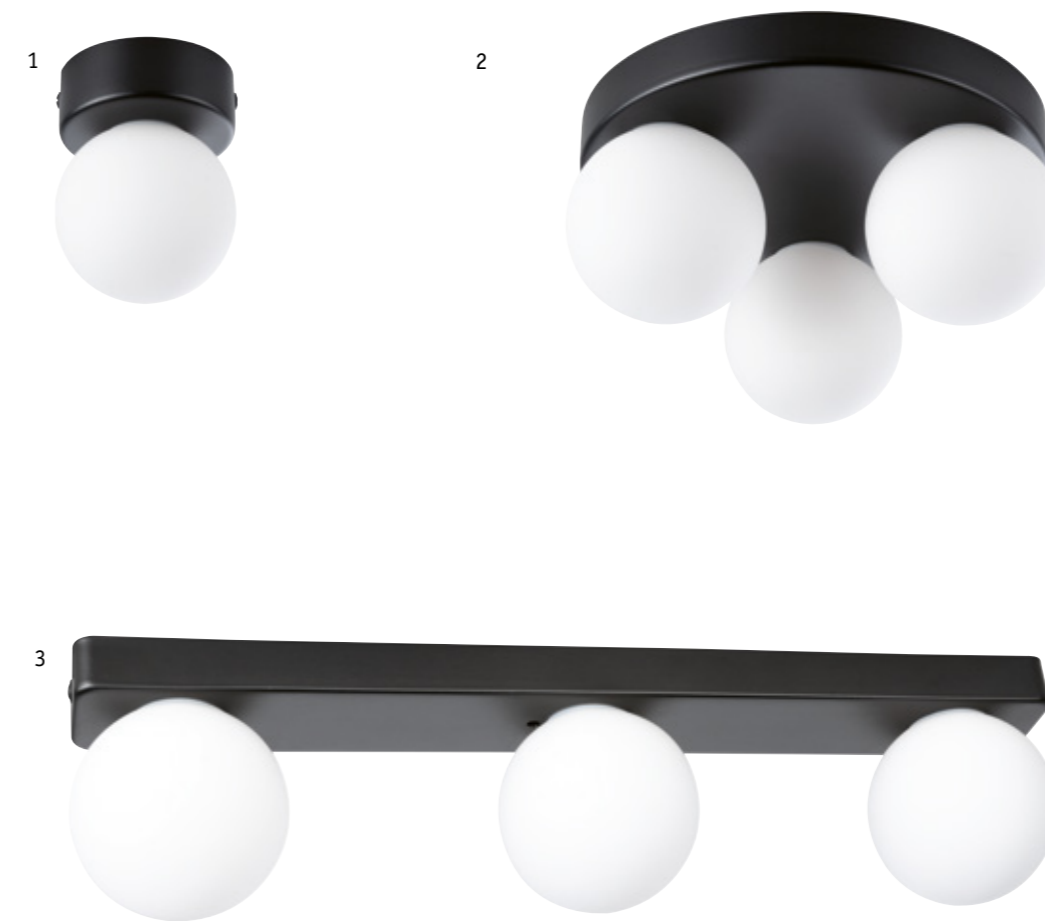

Replaceable lamp | Recommended lamp 28796 | black, satin | glass, metal | 230V | IP44

- Bayonet glass
- Dimmable
- Spare glass 80 mm 60411

Gove	Watt	Base	Dimensions	Item
1 Wall and ceiling luminaire	max. 20W	G9	∅106 ∅80 mm	71068
2 Ceiling luminaire	max. 3x 20W	G9	∅100 ∅220 mm	71069
3 Wall and ceiling luminaire	max. 3x 20W	G9	∅100 ⇄400 ⇄80 mm	71070

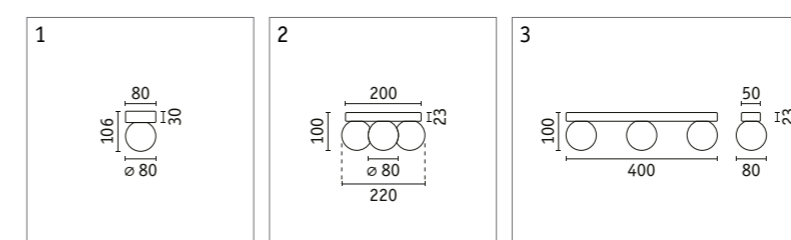



💡 Non-replaceable LED

🖌️ black, satin | 🏠 glass, metal | 230 V

🛡️ IP44

🟡 warm white

🕒 Bayonet glass

🔍 Spare glass 120 mm 60415

🔍 Spare glass 170 mm 60416

Gove	Lumen	Watt	Kelvin	Dimensions	Item
1 Wall and ceiling luminaire	400 lm	5 W	3000 K	±160 ø120 mm	71071
2 Wall and ceiling luminaire	900 lm	9 W	3000 K	±215 ø170 mm	71072
3 Pendant luminaire	900 lm	9 W	3000 K	±1500 ø170 mm	71073
4 Wall luminaire	400 lm	5 W	3000 K	±185 ø120 ↗150 mm	71074

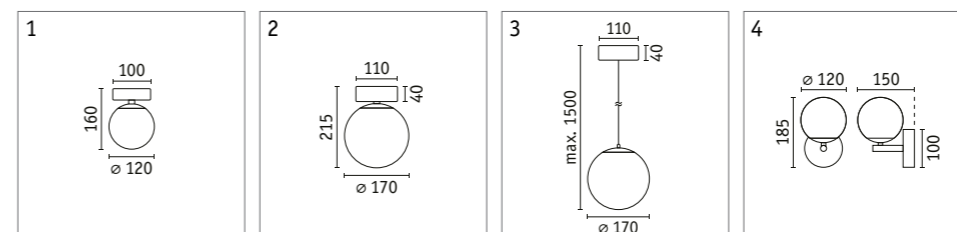



### Luena luminaire series

Unique combination of pure elegance and sheer ease

Flattering soft translucent shapes encased in modern clear glass and held in place by a glossy chrome metal base give these luminaires a very special glow in any bathroom. A touch of luxury and timeless design paired with high-quality materials and protection against water: the luminaires from the Luena series guarantee a long service life in both private and commercial bathrooms.

The Luena series also includes various luminaire types for walls, ceilings and mirrors, or for use as pendant luminaires whose cable can be shortened to perfectly complement different light zones and create a holistic lighting design. The luminaires are equipped with the latest LED technology, providing energy-saving and pleasantly warm white light, or they can be fitted with replaceable lamps for individual lighting designs. The glass elements can easily be removed without tools, featuring a bayonet lock for changing the lamp or cleaning.



Replaceable lamp | Recommended lamp 28611 | glass, metal | 230 V | IP44

- Bayonet glass
- Dimmable
- Spare glass 60412

Luena	Watt	Base	Dimensions	Item
1 Wall luminaire	max. 20 W	E14	↔100 ↕220 ↗125 mm	<b>C</b> 71076
2 Wall luminaire	max. 2x 20 W	E14	↔380 ↕100 ↗125 mm	<b>C</b> 71077

Replaceable lamp | Recommended lamp 28577 | white | glass, metal | 230 V | IP65

- Dimmable

Luena	Watt	Base	Dimensions	Item
3 Recessed luminaire	max. 35 W	GU10	↕125 ø 90 mm	<b>C</b> 71079

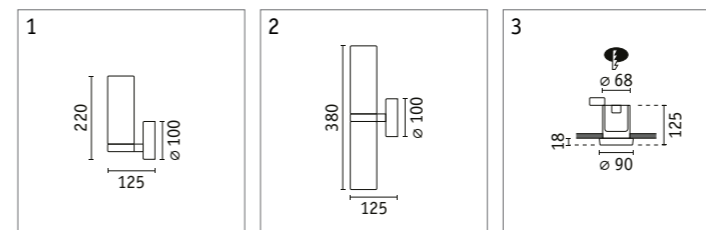



💡 Non-replaceable LED

🏠 glass, metal | 230V

🌊 IP44

● warm white

🕒 Bayonet glass

	Luena	Lumen	Watt	Kelvin	Dimensions	Item
1	Ceiling luminaire	600 lm	11.5 W	3000 K	±95 ø 250 mm	☑ 71078
2	Ceiling luminaire	860 lm	16.5 W	3000 K	±110 ø 350 mm	☑ 71075
3	Pendant luminaire	600 lm	11.5 W	3000 K	±1500 ø 250 mm	☑ 71080

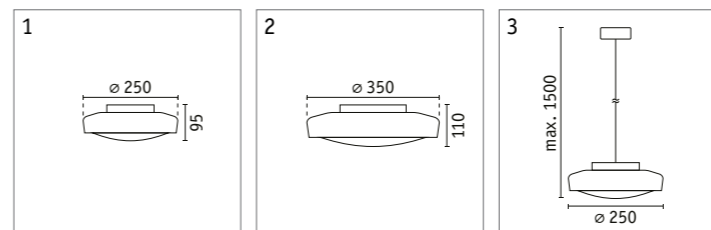





### Casca ceiling luminaires

Uniform room lighting based on the latest LED technology with WhiteSwitch technology

The unusual shape of the luminaire creates a sophisticated lighting effect: when switched on, only the inner edge lights up, with no light coming out of the centre. This means that the luminaires reduce unpleasant glare.

Casca incorporates the popular WhiteSwitch control technology. By pressing the existing standard light switch, the user can cycle through three white tones (warm white 3000 K, neutral white 4000 K, or daylight white 6500 K), so that the lighting can be customised to user requirements and the time of day (incl. memory function).



Non-replaceable LED

metal, plastic | 230 V

IP44

White Switch

Casca	Lumen	Watt	Kelvin	Dimensions	Item
1 Ceiling luminaire	1500 lm	16 W	3000–6500 K	∅71 ∅ 300 mm	<b>W</b> 78946
1 Ceiling luminaire	2100 lm	23 W	3000–6500 K	∅71 ∅ 400 mm	<b>W</b> 78947
2 Ceiling luminaire	1500 lm	16 W	3000–6500 K	∅71 ∅ 300 mm	<b>BA</b> 71094
2 Ceiling luminaire	2100 lm	23 W	3000–6500 K	∅71 ∅ 400 mm	<b>BA</b> 71095
3 Ceiling luminaire	1500 lm	16 W	3000–6500 K	∅71 ∅ 300 mm	<b>B</b> 71096



### Maro wall and ceiling luminaires

Luminaires with exciting double layer look made of frosted and clear glass

Classic and universal neutral bathroom luminaires for small bathrooms, guest bathrooms or bathroom areas in hotels, restaurants, offices & business premises.

High-quality plastic guarantees a long service life in humid environments.

A simple and subtle modern design enables universal use in bathroom areas, corridors and kitchens.

The plastic housing with bayonet fitting is simple to remove without tools, making it easy to maintain.

### Leonis curved ceiling luminaire

With motion sensor (707.22 and 707.24)

The luminaires are equipped with state-of-the-art LED technology, providing energy-saving and pleasant warm white light or neutral white light.

The user can set the distance and brightness at which the high-frequency sensor is triggered, as well as the length of time the light stays switched on – from 6 seconds to 30 minutes.



💡 Non-replaceable LED

🏠 plastic | 230 V

🛡️ IP44

	Wall and ceiling luminaires	Lumen	Watt	Kelvin	Dimensions	Item
1	Maro wall and ceiling luminaire	430 lm	6.8 W	3000 K	∅88.5 ∅155 mm	W 71081
2	Maro wall and ceiling luminaire	430 lm	6.8 W	3000 K	⇄155 ⇄88.5 ↻155 mm	W 71082
3	Leonis ceiling luminaire	890 lm	10 W	3000 K	∅95 ∅280 mm	W 70981
3	Leonis ceiling luminaire	920 lm	10 W	4000 K	∅95 ∅280 mm	W 70980
3	Leonis ceiling luminaire with HF sensor	780 lm	12.5 W	2700 K	∅95 ∅280 mm	W 70722
3	Leonis ceiling luminaire with HF sensor	780 lm	10.5 W	4000 K	∅95 ∅280 mm	W 70724



### Aviar ceiling panel with extremely flat design

Aviar, in a modern and elegant design, provides uniform ambient light based on state-of-the-art LED technology. The LED lamp is permanently integrated.

Some Aviar models include the popular WhiteSwitch control technology. By pressing the existing standard light switch, the user can cycle through three white tones (warm white 3000 K, neutral white 4000 K, or daylight white 6500 K), so that the lighting can be customised to user requirements and the time of day (incl. memory function).

The plastic housing is particularly durable, easy to clean and, thanks to its low weight, easy to install.



Non-replaceable LED

plastic | 230 V

IP44

Dimmable

Aviar	Lumen	Watt	Kelvin	Dimensions	Item
1 Ceiling luminaire	1800 lm	20 W	2700 K	∅ 62 ∅ 300 mm	<b>C</b> 70882
2 Ceiling luminaire	950 lm	13 W	3000 K	∅ 62 ∅ 220 mm	<b>W</b> 78923
3 Ceiling luminaire	950 lm	13 W	3000 K	∅ 62 ∅ 220 mm	<b>C</b> 78921
2 Ceiling luminaire	950 lm	13 W	4000 K	∅ 62 ∅ 220 mm	<b>W</b> 78924
3 Ceiling luminaire	950 lm	13 W	4000 K	∅ 62 ∅ 220 mm	<b>C</b> 78922



White Switch

Aviar	Lumen	Watt	Kelvin	Dimensions	Item
3 Ceiling luminaire	1050 lm	13 W	2700–6500 K	∅ 62 ∅ 220 mm	<b>C</b> 78925
1 Ceiling luminaire	1800 lm	18 W	2700–6500 K	∅ 62 ∅ 300 mm	<b>C</b> 78926
1 Ceiling luminaire	2200 lm	24 W	2700–6500 K	∅ 62 ∅ 360 mm	<b>C</b> 78927



## Cela LED ceiling luminaire with white light control

Cela provides uniform room lighting based on state-of-the-art energy-saving LED technology. The luminaire incorporates the popular WhiteSwitch control technology.

By pressing the existing standard light switch, the user can cycle through three white tones (warm white 3000 K, neutral white 4000 K, or daylight white 6500 K), so that the lighting can be customised to user requirements and the time of day (incl. memory function).

## Axin ceiling luminaire

Axin features a simple and modern design that suits any interior style. A bayonet fitting guarantees easy installation and tool-free lamp replacement.

The luminaire is dimmable when a suitable lamp is used.

*Don't forget:* include a dimmable lamp with an E27 base and a maximum diameter of 60 mm with your order!



Non-replaceable LED | plastic | 230 V | IP44

White Switch

Cela	Lumen	Watt	Kelvin	Dimensions	Item
1 Wall and ceiling luminaire	1650 lm	15.5 W	3000–6500 K	↔280 ↕50 ↗280 mm	W 79839

Replaceable lamp | Recommended lamp 28570 | plastic | 230 V | IP44

Dimmable

Axin	Watt	Base	Dimensions	Item
2 Wall and ceiling luminaire	max. 18 W	E27	↕74 ø 255 mm	W 78898



## Oka and Tega ceiling luminaires

The latest bathroom design trend: matt black and natural shades

Tega ceiling luminaires are perfect for use not only in bathrooms but also in all other living areas thanks to their great appearance and their simple and understated modern design.

The solid luminaire base is made from high-quality plastic, providing protection against water penetration and guaranteeing a long service life in humid environments.

The luminaires are equipped with WhiteSwitch control technology. By pressing the existing standard light switch, the user can cycle through three white tones (warm white 3000 K, neutral white 4000 K, or daylight white 6500 K), so that the lighting can be customised to user requirements and the time of day (incl. memory function).



Non-replaceable LED

plastic | 230 V

IP44

White Switch

Ceiling luminaires	Lumen	Watt	Kelvin	Dimensions	Item
1 Tega ceiling luminaire	1200 lm	22.5 W	3000–6500 K	∅64 ø 334 mm	<b>WD</b> 71085
2 Tega ceiling luminaire	1200 lm	22.5 W	3000–6500 K	∅64 ø 334 mm	<b>B</b> 71086
3 Oka ceiling luminaire	950 lm	24 W	3000–6500 K	∅105 ø 360 mm	<b>WD</b> 71083
4 Oka ceiling luminaire	950 lm	24 W	3000–6500 K	∅105 ø 360 mm	<b>B</b> 71084



## Atria Shine LED Panel

Elegant, ultra-flat panels with backlight technology in a Nordic pale wood look

The panels feature an ultra-flat shape with an installation height of only 28 mm and have a high-quality natural wood look. The plastic base material is very durable and easy to clean, even in humid environments.

The light is uniform with versions in cosy warm white or invigorating neutral white available.

Atria Shine is particularly easy to install thanks to the integrated quick clip and a rotary mounting plate.

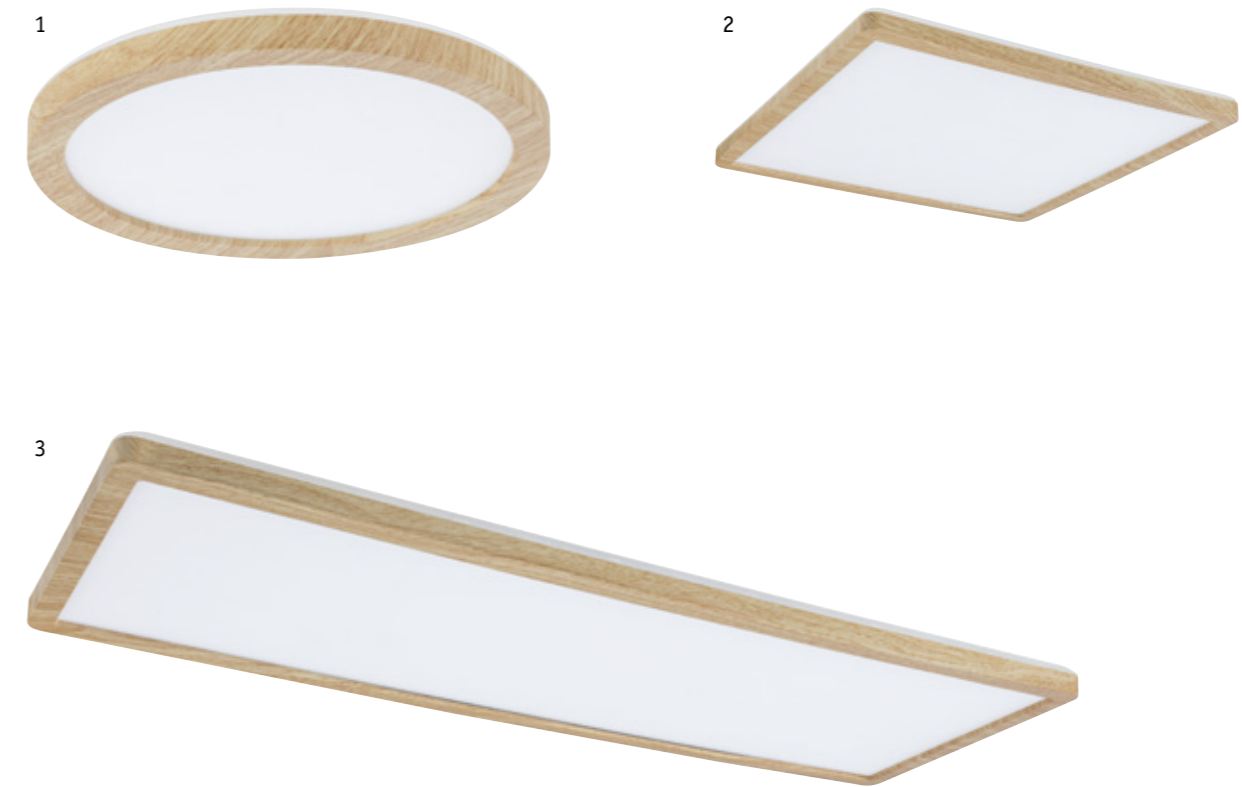

💡 Non-replaceable LED

📏 plastic | 230V

🛡️ IP44

Atria Shine	Lumen	Watt	Kelvin	Dimensions	Item
1 Ceiling luminaire	850 lm	11.2 W	3000 K	⇄30 ø 190 mm	<b>WD 71027</b>
1 Ceiling luminaire	1600 lm	16 W	3000 K	⇄30 ø 293 mm	<b>WD 71028</b>
1 Ceiling luminaire	2300 lm	22 W	3000 K	⇄30 ø 420 mm	<b>WD 71029</b>
1 Ceiling luminaire	850 lm	11.2 W	4000 K	⇄30 ø 190 mm	<b>WD 71032</b>
1 Ceiling luminaire	1600 lm	16 W	4000 K	⇄30 ø 293 mm	<b>WD 71033</b>
1 Ceiling luminaire	2300 lm	22 W	4000 K	⇄30 ø 420 mm	<b>WD 71034</b>
2 Ceiling luminaire	1600 lm	16 W	3000 K	⇄ 293 ⇄30 ↗293 mm	<b>WD 71030</b>
2 Ceiling luminaire	1600 lm	16 W	4000 K	⇄ 293 ⇄30 ↗293 mm	<b>WD 71035</b>
3 Ceiling luminaire	2300 lm	22 W	3000 K	⇄ 580 ⇄30 ↗200 mm	<b>WD 71031</b>
3 Ceiling luminaire	2300 lm	22 W	4000 K	⇄ 580 ⇄30 ↗200 mm	<b>WD 71036</b>



### Cosara LED mounting panels

A natural and cosy look for any room with an integrated efficient LED lamp

The light emitted by the Cosara mounting panels is exceptionally uniform thanks to the integrated LED technology, and can be either a cosy warm white or an invigorating neutral white.

The use of high-quality chunky-weave flat fabric in natural shades on the luminaire housing adds a unique highlight to any bathroom.

The textile exterior is dust and moisture-repellent. The Cosara is particularly easy to install thanks to the rotary mounting plate at the back.



💡 Non-replaceable LED

📏 | 🧵 fabric, plastic | 230 V

🛡️ IP44

Cosara	Lumen	Watt	Kelvin	Dimensions	Item
1 Ceiling luminaire	1300 lm	15 W	3000 K	⌀62 ø 300 mm	<b>FB</b> 71052
1 Ceiling luminaire	1300 lm	15 W	4000 K	⌀62 ø 300 mm	<b>FB</b> 71054
2 Ceiling luminaire	1300 lm	15 W	3000 K	⌀62 ø 300 mm	<b>FG</b> 71053
2 Ceiling luminaire	1300 lm	15 W	4000 K	⌀62 ø 300 mm	<b>FG</b> 71055



### Areo VariFit adjustable LED recessed panel

Even, glare-free ceiling light with state-of-the-art LED technology

AreoVariFit recessed panels are equipped with continuously positionable clamping springs so that they can be flexibly adapted to different installation conditions.

This makes them ideal for replacing old recessed luminaires of any size, or for new installations. The recessed panels impress with an ultra-flat design of max. 12 mm, and provide exceptionally uniform light.

The luminaires are equipped with Tunable White white tone control, which allows for the colour temperature to be adjusted continuously from 3000 K warm white to 6500 K daylight white. When the luminaires are switched on, the memory function immediately selects the last light colour and dimming function used.

The luminaires can be integrated and used in a home control hub that has a Zigbee interface, or can optionally be controlled directly with a Smart Home Zigbee remote control.

#### Recessed panel



Non-replaceable LED

plastic | 230 V

IP44

Tunable White

zigbee certified product

Dimmable



Areo VariFit	Lumen	Watt	Kelvin	Dimensions	Item
1 Recessed panel	1200 lm	13 W	3000–6500 K	∅12 ∅ 175 mm	<b>W</b> 93043
2 Recessed panel	1400 lm	16 W	3000–6500 K	∅12 ∅ 230 mm	<b>W</b> 93044
3 Recessed panel	1200 lm	13 W	3000–6500 K	∅12 ∅ 175 mm	<b>CM</b> 93045
4 Recessed panel	1400 lm	16 W	3000–6500 K	∅12 ∅ 230 mm	<b>CM</b> 93046
5 Recessed panel	1200 lm	13 W	3000–6500 K	⇄175 ∅12 ⇄175 mm	<b>W</b> 93047
6 Recessed panel	1400 lm	16 W	3000–6500 K	⇄230 ∅12 ⇄230 mm	<b>W</b> 93048
7 Recessed panel	1200 lm	13 W	3000–6500 K	⇄175 ∅12 ⇄175 mm	<b>B</b> 79966
8 Recessed panel	1400 lm	16 W	3000–6500 K	⇄230 ∅12 ⇄230 mm	<b>B</b> 79967

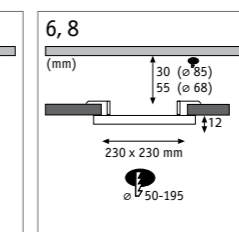
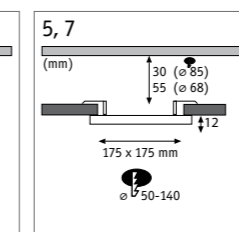
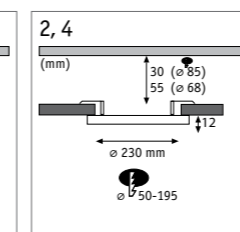
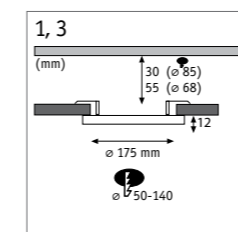





## Veluna VariFit adjustable LED recessed panel

### Ceiling panel with extremely flat design

Veluna VariFit recessed panels are equipped with continuously positionable clamping springs so that they can be flexibly adapted to different installation conditions.

This makes them ideal for replacing old recessed luminaires of any size, or for new installations. The recessed panels impress with an ultra-flat construction of max. 10 mm, a frameless design and very uniform light.

The Zigbee luminaires are equipped with Tunable White white control, which allows the colour temperature to be adjusted continuously from 3000 K warm white to 6500 K daylight white. When the luminaires are switched on, the memory function immediately selects the last light colour and dimming function used.

Luminaires featuring WhiteSwitch control technology allow the user to cycle through three white tones (warm white 3000 K, neutral white 4000 K, or daylight white 6500 K) by pressing the existing standard wall switch, so that the lighting can be customised to user requirements and the time of day.

### Recessed panel

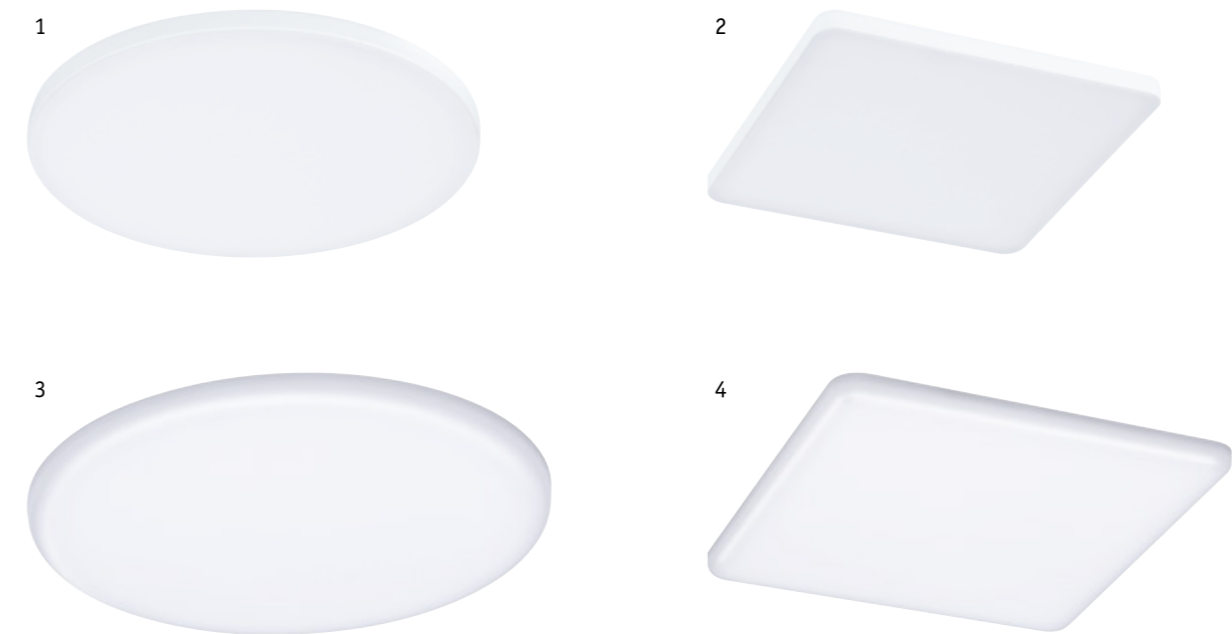

Non-replaceable LED

plastic | 230 V

IP44

Tunable White | zigbee certified product | Dimmable



	Recessed panel	Lumen	Watt	Kelvin	Dimensions	Item
1	Veluna VariFit Edge	1000 lm	15.5 W	3000–6500 K	∅9 ∅ 160 mm	<b>W</b> 79956
1	Veluna VariFit Edge	1400 lm	18 W	3000–6500 K	∅9 ∅ 200 mm	<b>W</b> 79957
2	Veluna VariFit Edge	1000 lm	15.5 W	3000–6500 K	⇄160 ∅9 ↗ 160 mm	<b>W</b> 79958
2	Veluna VariFit Edge	1400 lm	18 W	3000–6500 K	⇄200 ∅9 ↗ 200 mm	<b>W</b> 79959
3	Veluna VariFit	1000 lm	15 W	3000–6500 K	∅10 ∅ 185 mm	<b>SA</b> 95386
3	Veluna VariFit	1000 lm	17 W	3000–6500 K	∅10 ∅ 215 mm	<b>SA</b> 95387
4	Veluna VariFit	1000 lm	15 W	3000–6500 K	⇄185 ∅10 ↗ 185 mm	<b>SA</b> 95384
4	Veluna VariFit	1300 lm	17 W	3000–6500 K	⇄215 ∅10 ↗ 215 mm	<b>SA</b> 95385

White Switch

	Recessed panel	Lumen	Watt	Kelvin	Dimensions	Item
4	Veluna VariFit	1000 lm	14 W	3000–6500 K	⇄185 ∅10 ↗ 185 mm	<b>SA</b> 95379
4	Veluna VariFit	1300 lm	17 W	3000–6500 K	⇄215 ∅10 ↗ 215 mm	<b>SA</b> 95380

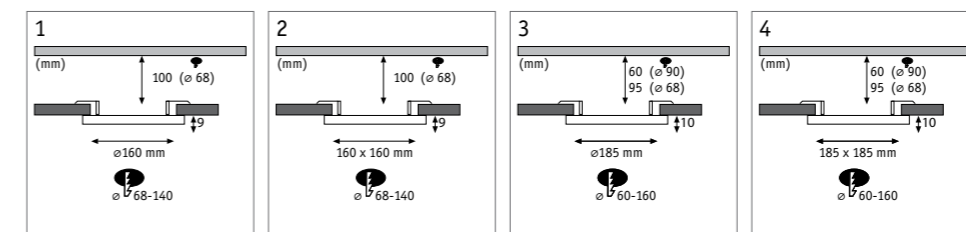



### Pendant luminaires for unique decorative light accents in the bathroom

Concrete paired with trendy chrome, timeless black, or black and chrome: these pendant luminaires make a statement for cosy light throughout the house.

Lamp tip: choose a dimmable lamp if you want to control the brightness. All pendant luminaires are compatible with a wide selection of E27-base decorative lamps in the Paulmann range.



### Pendant luminaires



Replaceable lamp metal | 230V IP44

Dimmable

Larus	Watt	Base	Dimensions	Item
1 Pendant luminaire	max. 60 W	E27	29078 ⚡ 1590 ø110 mm	<b>C</b> 79753
2 Pendant luminaire	max. 60 W	E27	29077 ⚡ 1590 ø110 mm	<b>BC</b> 79754

Replaceable lamp silicone, plastic | 230V IP44

Dimmable

Ketil	Watt	Base	Dimensions	Item
3 Pendant luminaire	max. 20 W	E27	29079 ⚡ 2000 ø92 mm	<b>B</b> 50346

Replaceable lamp concrete, metal | 230V IP44

Dimmable

Verve	Watt	Base	Dimensions	Item
4 Pendant luminaire	max. 20 W	E27	28698 ⚡ 2000 ø92 mm	<b>C</b> 70890



### Zyli and Tube Spotlight Series

The wide range of spots in this series enables a variety of applications for bathroom walls and ceilings. Individual areas can be illuminated quickly and flexibly by simply aligning the swivelling spot heads. Multiple spotlights enable a variety of lighting accents, and are ideal in bathrooms with few power outlets.

The spots are dimmable when used with a suitable lamp.

*Don't forget:* include a suitable dimmable lamp in your order!

### Spot series

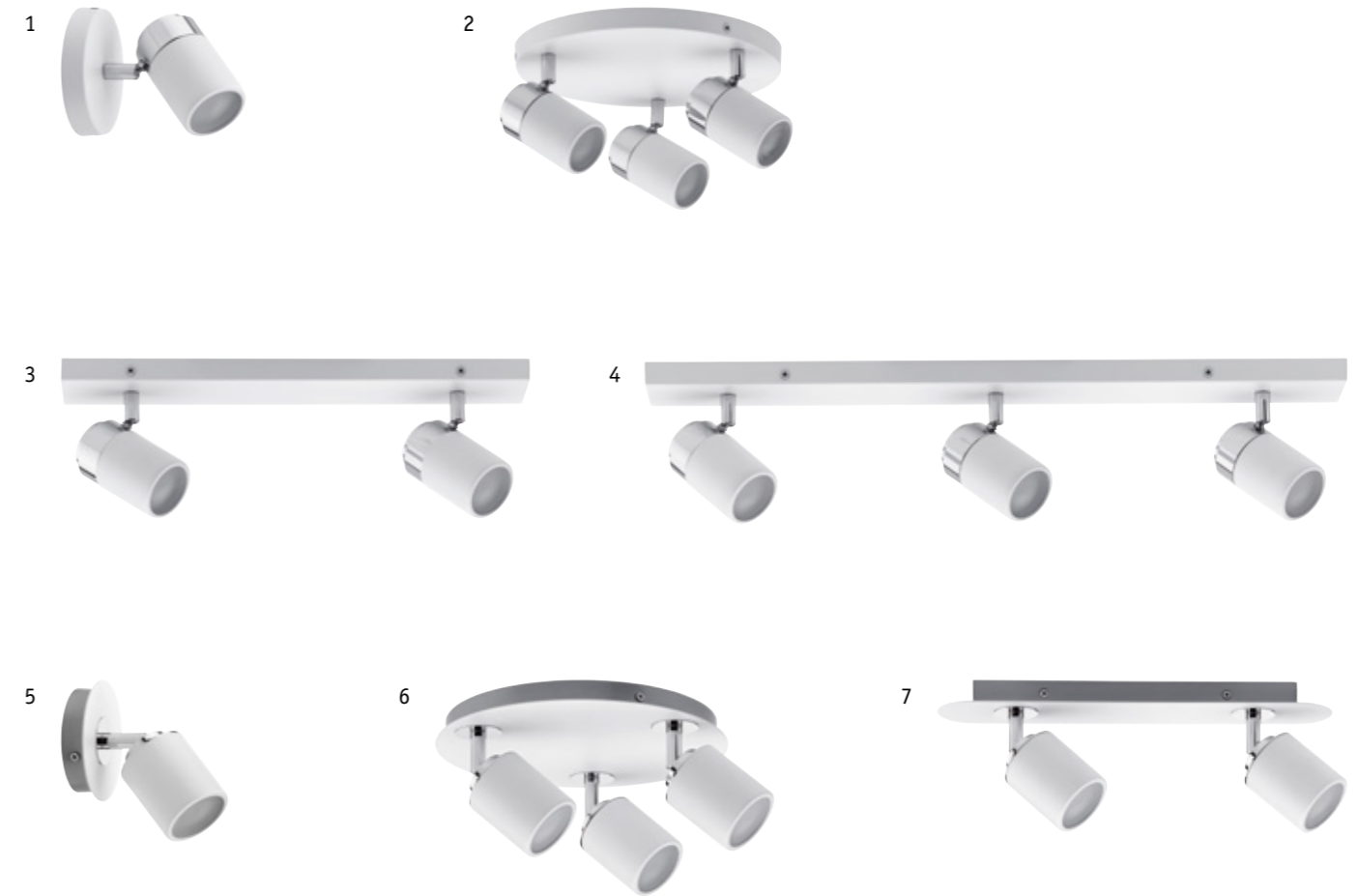

Replaceable lamp | Recommended lamp 28577

metal | 230V

IP44

Dimmable

Spots	Watt	Base	Dimensions	Item
1 Zyli spot	max. 10 W	GU10	∅110 ∅100 mm	W 66710
2 Zyli spot	max. 3x 10 W	GU10	∅110 ∅250 mm	W 66712
3 Zyli spot	max. 2x 10 W	GU10	↔400 ∅110 ↗70 mm	W 66711
4 Zyli spot	max. 3x 10 W	GU10	↔600 ∅110 ↗70 mm	W 66713
5 Tube spot	max. 10 W	GU10	∅138 ↗94 ∅100 mm	W 66717
6 Tube spot	max. 3x 10 W	GU10	∅94 ∅250 mm	W 66719
7 Tube spot	max. 2x 10 W	GU10	↔350 ∅94 ↗65 mm	W 66718



### Carolina Spotlight Series

Modern anthracite is a great match for a wide range of uses and the simple design, blends seamlessly into any bathroom

- The swivelling spot heads can easily be aligned for optimal light deflection and allow for a variety of lighting solutions.
- The luminaires are dimmable when a suitable lamp is used.

*Don't forget:* include a suitable dimmable lamp in your order!



Replaceable lamp

metal | 230V

IP44

Dimmable

Carolina	Watt	Base	Dimensions	Item
1 Spot	max. 10 W	GU10	28751 ∅110 ∅80 mm	DG 66750
2 Spot	max. 3x 10 W	GU10	28751 ∅110 ∅200 mm	DG 66752
3 Spot	max. 2x 10 W	GU10	28751 ⇄264 ∅128 ↗80 mm	DG 66751
4 Spot	max. 10 W	GU10	28286 ∅110 ∅80 mm	c 66749
5 Spot	max. 3x 10 W	GU10	28286 ∅110 ∅200 mm	c 66747
6 Spot	max. 2x 10 W	GU10	28286 ⇄264 ∅128 ↗80 mm	c 66748



### Calla IP65 LED recessed luminaires

Calla is compact, individual and luminous and equipped with the latest efficient LED technology. Some versions are swivelling for optimal light deflection. All variants have IP65 protection against jets of water.

Some of the luminaires are equipped with WhiteSwitch control technology. By pressing the existing standard light switch, the user can cycle through three white tones (warm white 3000 K, neutral white 4000 K, or daylight white 6500 K), so that the lighting can be customised to user requirements and the time of day (incl. memory function).

### Recessed luminaires



Non-replaceable LED

plastic | 230 V

IP65

neutral white

Calla	Lumen	Watt	Kelvin	Dimensions	↔	↕	Item
1 Rigid recessed luminaire	400 lm	5 W	4000 K	∅ 85 mm	68 mm	55 mm	W 99936
2 Rigid recessed luminaire	400 lm	5 W	4000 K	∅ 85 mm	68 mm	55 mm	CM 99937
3 Rigid recessed luminaire	370 lm	7 W	4000 K	∅ 80 mm	60 mm	50 mm	W 93670
4 Swivelling recessed luminaire	530 lm	6 W	4000 K	∅ 90 mm	68 mm	55 mm	W 99926
5 Swivelling recessed luminaire	530 lm	6 W	4000 K	∅ 90 mm	68 mm	55 mm	CM 99928
6 Swivelling recessed luminaire	500 lm	6 W	4000 K	∅ 90 mm	68 mm	55 mm	B 92461

neutral white | Dimmable

Calla	Lumen	Watt	Kelvin	Dimensions	↔	↕	Item
4 Swivelling recessed luminaire	460 lm	5.2 W	4000 K	∅ 90 mm	68 mm	55 mm	W 99930
5 Swivelling recessed luminaire	460 lm	5.2 W	4000 K	∅ 90 mm	68 mm	55 mm	CM 99932

White Switch

Calla	Lumen	Watt	Kelvin	Dimensions	↔	↕	Item
4 Swivelling recessed luminaire	400 lm	5.5 W	2700–6500 K	∅ 90 mm	68 mm	55 mm	W 92998
4 Swivelling recessed luminaire	400 lm	5 W	3000–6500 K	∅ 90 mm	68 mm	55 mm	W 99934

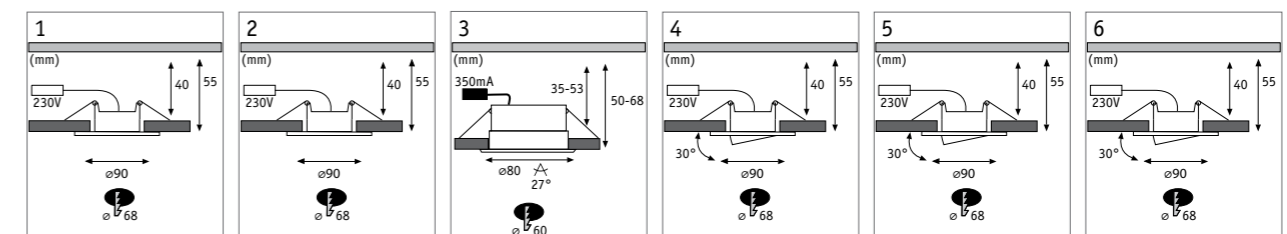



### Nova Plus IP65 swivelling coin LED recessed luminaires

Available in various versions and colours, the swivelling recessed luminaires with a warm white replaceable LED coin are the ideal choice for basic lighting in bathrooms.

For new installations or for replacing existing installations: they can be installed in ceilings with a cavity of only 30 millimetres. Thanks to the simple mounting method with retaining springs, the ceiling remains undamaged, even after repeated installations and removals.

The dimming function lets you adjust the brightness according to your needs: warm white basic lighting and cosy mood lighting in a single unit!

Thanks to IP65 protection, the luminaire is specially protected against penetration by water jets, making it ideal for installation in bathrooms.

### Recessed luminaires



☑ Replaceable coin

☑ aluminium | 230V

☑ IP65

● warm white | ☑ Dimmable

	Nova Plus	Lumen	Watt	Kelvin	Dimensions	↔↔L	↕↕L	Item
1	Recessed luminaire	460 lm	7 W	2700 K	↔93 ↕93 mm	83 mm	90 mm	W C   92904
2	Recessed luminaire	460 lm	7 W	2700 K	∅ 93 mm	83 mm	90 mm	W C   92903
3	Recessed luminaire	460 lm	7 W	2700 K	∅ 93 mm	83 mm	90 mm	W   92897
4	Recessed luminaire	460 lm	7 W	2700 K	∅ 93 mm	83 mm	90 mm	BI   92899

○ neutral white | ☑ Dimmable

	Nova Plus	Lumen	Watt	Kelvin	Dimensions	↔↔L	↕↕L	Item
5	Recessed luminaire	470 lm	6 W	4000 K	↔93 ↕93 mm	83 mm	95 mm	W C   93674
6	Recessed luminaire	470 lm	6 W	4000 K	∅ 93 mm	83 mm	95 mm	W C   93673
7	Recessed luminaire	470 lm	6 W	4000 K	∅ 93 mm	83 mm	95 mm	W   93672
8	Recessed luminaire	470 lm	6 W	4000 K	∅ 93 mm	83 mm	95 mm	BI   93671

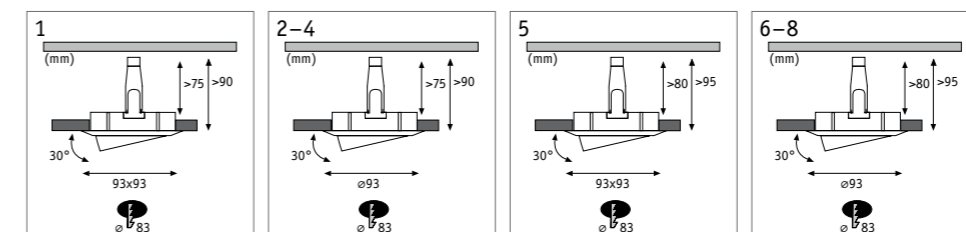



### Nova Plus IP65 GU10 / GU5.3 swivelling LED recessed luminaires

In various versions and colours, the IP65 swivelling recessed luminaires are the ideal choice for basic lighting in bathrooms.

For new installations or for replacing existing installations: they can be installed in ceilings with a cavity of only 75 millimetres. Thanks to the simple mounting method with retaining springs, the ceiling remains undamaged, even after repeated installations and removals.

Choose from a GU5.3 or GU10 lamp depending on personal lighting taste.

Thanks to IP65 protection, the luminaire is specially protected against penetration by water jets, making it ideal for installation in bathrooms.



Replaceable lamp | Recommended lamp 92968 | aluminium, zinc | 12V / 230V | IP65

incl. GU10 incl. GU5,3

Nova Plus	Watt	Base	Dimensions	↕	↕	Item
1 Recessed luminaire	max. 35 W	GU5.3 / GU10	↔93 ↕93 mm	83 mm	60 / 90 mm	<b>W</b> <b>C</b> 93664
2 Recessed luminaire	max. 35 W	GU5.3 / GU10	∅93 mm	83 mm	60 / 90 mm	<b>W</b> <b>C</b> 93663
4 Recessed luminaire	max. 35 W	GU5.3 / GU10	∅93 mm	83 mm	60 / 90 mm	<b>W</b> 93661
3 Recessed luminaire	max. 35 W	GU5.3 / GU10	∅93 mm	83 mm	60 / 90 mm	<b>BI</b> 93662
5 Recessed luminaire	max. 35 W	GU5.3 / GU10	∅93 mm	83 mm	60 / 90 mm	<b>B</b> 92460

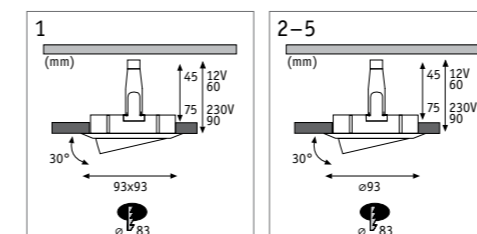



## Nova Plus IP65 rigid coin LED recessed luminaires

Available in various versions and colours, the rigid recessed luminaires with a warm white replaceable LED coin are the ideal choice for basic lighting in bathrooms.

For new installations or for replacing existing installations: they can be installed in ceilings with a cavity of only 30 millimetres. Thanks to the simple mounting method with retaining springs, the ceiling remains undamaged, even after repeated installations and removals.

The dimming function lets you adjust the brightness according to your needs: warm white basic lighting and cosy mood lighting in a single unit!

Thanks to IP65 protection, the luminaire is specially protected against penetration by water jets, making it ideal for installation in bathrooms.



Replaceable coin

aluminium, zinc | 230 V

IP65

Dimmable

	Nova Plus	Lumen	Watt	Kelvin	Dimensions	↔	↕	Item
1	Recessed luminaire	470 lm	6 W	2700 K	∅ 78 mm	68 mm	45 mm	<b>W</b> 93881
2	Recessed luminaire	470 lm	6 W	2700 K	∅ 78 mm	68 mm	45 mm	<b>BI</b> 93882
3	Recessed luminaire	470 lm	6 W	2700 K	∅ 78 mm	68 mm	45 mm	<b>C</b> 93883

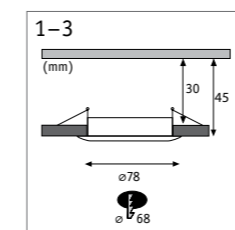





### Nova Plus IP65 swivelling LED recessed luminaires

Available in various designs and colours, these are the ideal choice for basic lighting in bathrooms thanks to their replaceable LED coin.

For new installations or for replacing existing installations: they can be installed in ceilings with a cavity of only 75 millimetres. Thanks to the simple mounting method with retaining springs, the ceiling remains undamaged, even after repeated installations and removals.

The dimming function lets you adjust the brightness according to your needs: warm white basic lighting and cosy mood lighting in a single unit!

Thanks to IP65 protection, the luminaire is specially protected against penetration by water jets, making it ideal for installation in bathrooms.

### Recessed luminaires



Replaceable coin

aluminium, zinc | 230 V

IP65

Dimmable

	Nova Plus	Lumen	Watt	Kelvin	Dimensions	↕	↕	Item
1	Recessed luminaire	470 lm	6 W	2700 K	∅ 93 mm	83 mm	45 mm	<b>W</b>   93681
2	Recessed luminaire	470 lm	6 W	2700 K	∅ 93 mm	83 mm	45 mm	<b>W</b>   <b>c</b>   93685
3	Recessed luminaire	470 lm	6 W	2700 K	∅ 93 mm	83 mm	45 mm	<b>c</b>   93683
4	Recessed luminaire	470 lm	6 W	2700 K	∅ 93 mm	83 mm	45 mm	<b>B</b>   92459

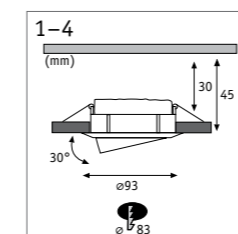



### Nova rigid LED coin recessed luminaires

Available in various designs and colours, these are the ideal choice for basic lighting in bathrooms thanks to their warm white replaceable LED coin.

For new installations or for replacing existing installations: they can be installed in ceilings with a cavity of only 30 millimetres. Thanks to the simple mounting method with retaining springs, the ceiling remains undamaged, even after repeated installations and removals.

### Recessed luminaires



☑ Replaceable coin

☑ aluminium | 230 V

☑ IP44

● warm white

	Nova	Lumen	Watt	Kelvin	Dimensions	↔	↓	Item
1	Recessed luminaire	470 lm	6 W	2700 K	∅ 78 mm	68 mm	45 mm	W 93459
2	Recessed luminaire	470 lm	6 W	2700 K	∅ 78 mm	68 mm	45 mm	BA 93461
3	Recessed luminaire	470 lm	6 W	2700 K	∅ 78 mm	68 mm	45 mm	BI 93457
4	Recessed luminaire	460 lm	6.5 W	2700 K	∅ 78 mm	68 mm	75 mm	W 93441
5	Recessed luminaire	460 lm	6.5 W	2700 K	∅ 78 mm	68 mm	75 mm	BA 93443
6	Recessed luminaire	460 lm	6.5 W	2700 K	∅ 78 mm	68 mm	75 mm	BI 93439

💡 Non-replaceable LED

☑ aluminium | 230 V

☑ IP44

○ neutral white

	Nova	Lumen	Watt	Kelvin	Dimensions	↔	↓	Item
1	Recessed luminaire	470 lm	6.5 W	4000 K	∅ 78 mm	68 mm	45 mm	W 92978
3	Recessed luminaire	470 lm	6.5 W	4000 K	∅ 78 mm	68 mm	45 mm	BI 92977

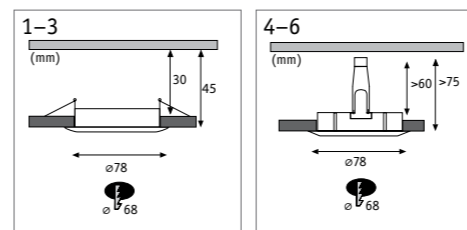



## Nova rigid LED coin recessed luminaires

Available in various designs and colours, these are the ideal choice for basic lighting in bathrooms thanks to their warm white replaceable LED coin.

For new installations or for replacing existing installations: they can be installed in ceilings with a cavity of only 30 millimetres. Thanks to the simple mounting method with retaining springs, the ceiling remains undamaged, even after repeated installations and removals.

Including an optional version with 3-step dimming technology: the user can cycle through brightness levels by pressing their standard wall switch, so you get warm white basic lighting and cosy, comfortable mood lighting all in a single unit.

No separate dimmer is required.

## Recessed luminaires



Replaceable coin

aluminium | 230V

IP44

warm white

3-step dim

	Nova	Lumen	Watt	Kelvin	Dimensions	↔	↓	Item
1	Recessed luminaire	470 lm	6 W	2700 K	ø 78 mm	68 mm	45 mm	W 93495
2	Recessed luminaire	470 lm	6 W	2700 K	ø 78 mm	68 mm	45 mm	BA 93497
3	Recessed luminaire	470 lm	6 W	2700 K	ø 78 mm	68 mm	45 mm	BI 93493
4	Recessed luminaire	460 lm	6.5 W	2700 K	ø 78 mm	68 mm	75 mm	W 93477
5	Recessed luminaire	460 lm	6.5 W	2700 K	ø 78 mm	68 mm	75 mm	BA 93479
6	Recessed luminaire	460 lm	6.5 W	2700 K	ø 78 mm	68 mm	75 mm	BI 93475

Replaceable coin

aluminium | 230V

IP44

neutral white

3-step dim

	Nova	Lumen	Watt	Kelvin	Dimensions	↔	↓	Item
1	Recessed luminaire	420 lm	6.5 W	4000 K	ø 78 mm	68 mm	45 mm	W 92982
3	Recessed luminaire	450 lm	6.5 W	4000 K	ø 78 mm	68 mm	45 mm	BI 92981

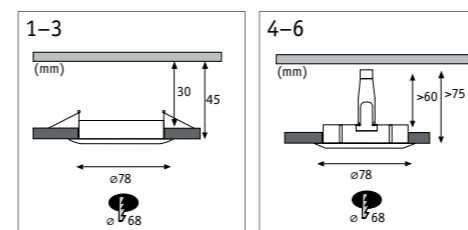



### Nova mini rigid LED recessed luminaires

The rigid Nova mini recessed luminaire comes in different versions with modern warm white LED lighting, offering a whole range of new possibilities thanks to its reduced size. It is ideal for spot lighting, niches and cladding.

The unique 35 mm coin is replaceable, flat and can be linked an unlimited number of times.

### Recessed luminaires



Replaceable coin

aluminium | 230V

IP44

● warm white

	Nova mini	Lumen	Watt	Kelvin	Dimensions	↔	↓	Item
1	Recessed luminaire	310 lm	4 W	2700 K	∅ 65 mm	54 mm	50 mm	<b>W</b> 94298
2	Recessed luminaire	310 lm	4 W	2700 K	∅ 65 mm	54 mm	50 mm	<b>BA</b> 94304
3	Recessed luminaire	310 lm	4 W	2700 K	∅ 65 mm	54 mm	50 mm	<b>BI</b> 94300
4	Recessed luminaire	310 lm	4 W	2700 K	∅ 65 mm	54 mm	50 mm	<b>C</b> 94302

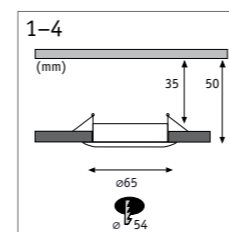



### Cole LED coin recessed luminaires

The Cole recessed luminaire in classic and modern colour combinations blends almost seamlessly into the ceiling, thanks to the recessed lamp. The light of the recessed coins on the matt surface in different colours provides soft, glare-free lighting.

It also features some brilliant technology: the replaceable LED coin provides pleasant, warm white light and can be dimmed in three stages with a conventional light switch.

### Recessed luminaires

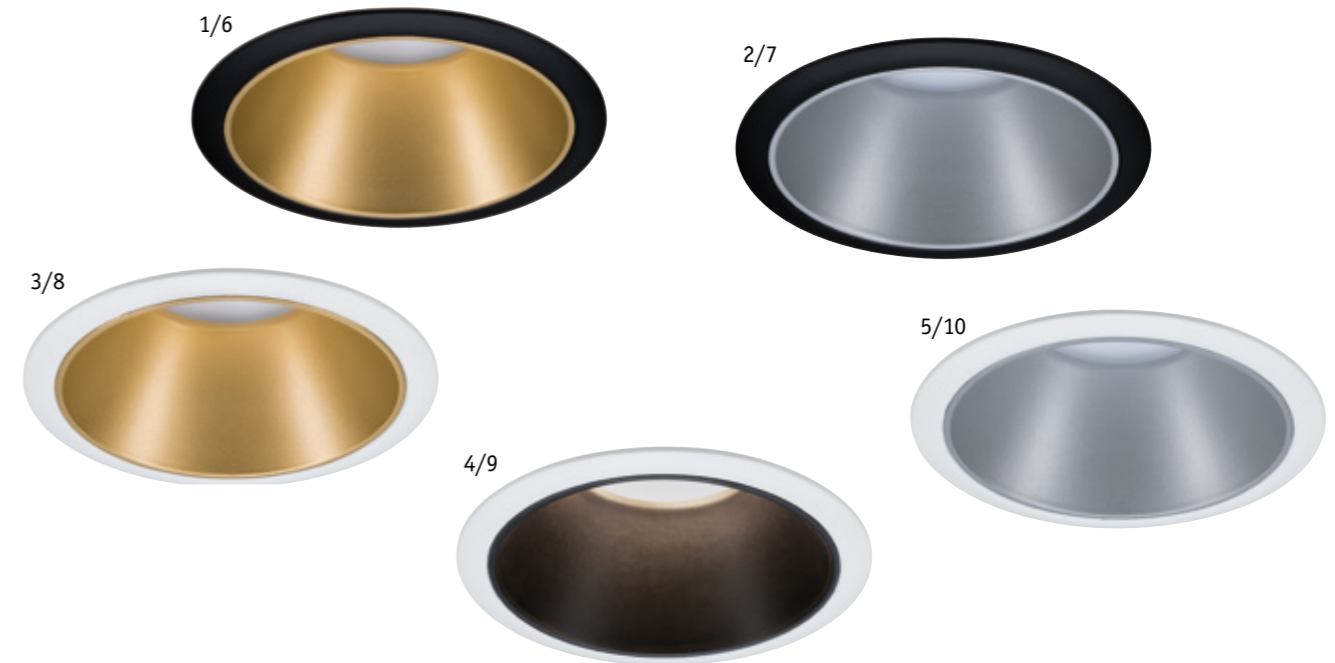

☞ Replaceable coin

☑ | ☒ plastic, aluminium zinc | 230 V

☼ IP44

● warm white | ☐ 3-step dim

	Cole	Lumen	Watt	Kelvin	Dimensions	↔L	↕L	Item
1	Recessed luminaire	470 lm	6 W	2700 K	∅ 88 mm	80 mm	70 mm	<b>B</b> <b>AU</b> 93403
2	Recessed luminaire	470 lm	6 W	2700 K	∅ 88 mm	80 mm	70 mm	<b>B</b> <b>AG</b> 93407
3	Recessed luminaire	470 lm	6 W	2700 K	∅ 88 mm	80 mm	70 mm	<b>W</b> <b>AU</b> 93405
4	Recessed luminaire	470 lm	6 W	2700 K	∅ 88 mm	80 mm	70 mm	<b>W</b> <b>B</b> 93401
5	Recessed luminaire	470 lm	6 W	2700 K	∅ 88 mm	80 mm	70 mm	<b>W</b> <b>AG</b> 93409

💡 Lamp replaceable | ☑ Compatible with all GU10 lamps

☑ | ☒ plastic, aluminium zinc | 230 V

☼ IP44

	Cole	Watt	Base	Dimensions	↔L	↕L	Item
6	Recessed luminaire	max. 10 W	GU10	∅ 88 mm	80 mm	110 mm	<b>B</b> <b>AU</b> 93395
7	Recessed luminaire	max. 10 W	GU10	∅ 88 mm	80 mm	110 mm	<b>B</b> <b>AG</b> 93397
8	Recessed luminaire	max. 10 W	GU10	∅ 88 mm	80 mm	110 mm	<b>W</b> <b>AU</b> 93396
9	Recessed luminaire	max. 10 W	GU10	∅ 88 mm	80 mm	110 mm	<b>W</b> <b>B</b> 93394
10	Recessed luminaire	max. 10 W	GU10	∅ 88 mm	80 mm	110 mm	<b>W</b> <b>AG</b> 93398

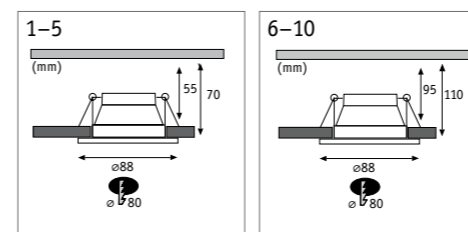



### Mirra LED mirror

#### Illuminated mirror in timeless design with astonishing extra functions

An addition to the successful Mirra series with matt black frame colour, in the popular oval mirror shape or with a modern suspension option using a black leather strap.

Mirra illuminated mirrors are perfect for use in private bathrooms as well as commercial bathroom areas thanks to their elegant look and simple and understated yet modern design.

By touching the control buttons integrated in the mirror, you can:

- Change the light colour using White Switch control technology (incl. memory function)
- Continuously dim the light of the mirror
- Activate the mirror's heating function, which clears the fogged mirror in a matter of seconds after a bath or shower

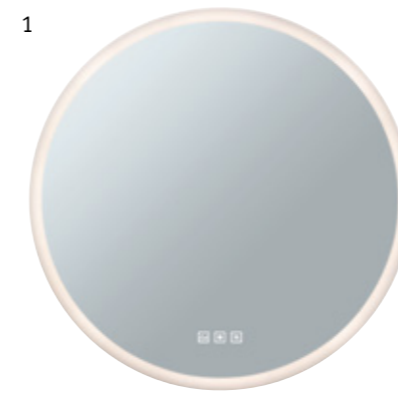

💡 Non-replaceable LED

📏 metal, acrylic | 230 V

🌊 IP44

📏 White Switch

🌞 Dimmable

🔥 Heating function

Mirra	Lumen	Watt	Kelvin	Dimensions	Item
1 Round illuminated mirror	1580 lm	21 W	2700 4000 6500 K	∅ 600 ↗ 28 mm	📦 78952
2 Oval illuminated mirror	1400 lm	22 W	3000 4000 6500 K	↕ 800 ↗ 27 ⇄ 600 mm	📦 71087
3 Rectangular illuminated mirror in landscape format	1600 lm	22 W	2700 4000 6500 K	↕ 800 ↗ 28 ⇄ 600 mm	📦 93013
4 Rectangular illuminated mirror in portrait format	1600 lm	22 W	2700 4000 6500 K	↕ 600 ↗ 28 ⇄ 800 mm	📦 78951



Illuminated mirrors

1

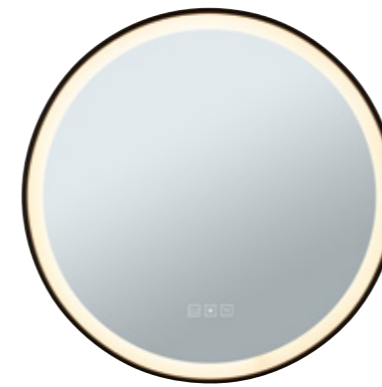

2

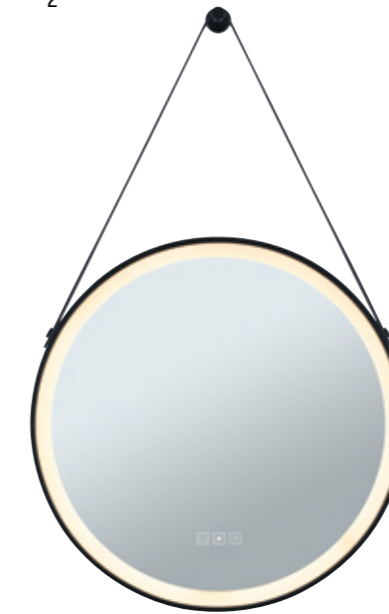

💡 Non-replaceable LED

📏 | 🏗️ metal, acrylic | 230V

🌊 IP44

📺 White Switch

🕒 Dimmable

🔥 Heating function

Mirra	Lumen	Watt	Kelvin	Dimensions	Item
1 Round illuminated mirror	750 lm	11,5W	3000 4000 6500 K	ø 590 ⚡ 31 mm	<b>B</b> 71088
2 Round illuminated mirror with strip	750 lm	11,5W	3000 4000 6500 K	ø 590 ⚡ 31 mm	<b>B</b> 71089





1



2



3



4



💡 Non-replaceable LED

📏 | 🏠 metal, mirror | 230 V

🌊 IP44

 Tunable White

Miro	Lumen	Watt	Kelvin	Dimensions	Item
1 Round illuminated mirror with shelf	160 lm	10.5 W	2700–6500 K	∅ 500 ↗ 120 mm	<b>B</b> 71090
2 Round illuminated mirror with shelf	500 lm	11 W	3000–6500 K	∅ 500 ↗ 105 mm	<b>B</b> 71091
3 Round illuminated mirror with strip	200 lm	7.5 W	2700–6500 K	∅ 400 ↗ 40 mm	<b>B</b> 71092
4 Rectangular illuminated mirror with shelf	180 lm	11 W	3000–6500 K	↔ 600 ↗ 800 ↗ 27 mm	<b>B</b> 71093



### Miro LED mirror

Illuminated mirror in timeless design with white light control and optional shelf

Miro illuminated mirrors are perfect for use in private bathrooms as well as commercial bathroom areas thanks to their elegant look and simple and understated yet modern design.

State-of-the-art LED technology provides the perfect lighting for the user thanks to a virtually invisible lighting strip in the housing.

The integrated shelf helps keep the bathroom tidy.

Touching the control buttons integrated in the mirror allows the user to cycle continuously through the white light colours – from warm white (2700 Kelvin start mode) for relaxation, to daylight white (6500 Kelvin) for better concentration.





### Jora LED vanity mirror

Illuminated folding vanity mirror with triple magnification

White Switch control technology: by using the touch switch integrated in the mirror, the light colour can be changed from the colour temperature 2700 K warm white, to 4000 K neutral white, up to 6500 K daylight white (incl. memory function).

The plug cable is detachable for 230V direct connection.

### Bela LED vanity mirror

Illuminated folding vanity mirror with triple magnification and integrated LED lamp for ideal illumination with a pleasant warm white colour temperature of 3000 K.

The plug cable is detachable for 230V direct connection.

### Illuminated mirrors

1



2



Non-replaceable LED

metal, acrylic | 230 V

IP44

White Switch



Jora	Lumen	Watt	Kelvin	Dimensions	Item
1 Illuminated mirror	60 lm	3.3 W	2700–6500 K	⇄190 ⇄205 ⇄362 mm	c 78933

warm white



Bela	Lumen	Watt	Kelvin	Dimensions	Item
2 Illuminated mirror	260 lm	5.7 W	3000 K	⇄230 ⇄230 ⇄295 mm	c 70468



### Double Hook LED cabinet and mirror luminaire

The Galeria Double Hook cabinet and mirror luminaire uses efficient LED technology to provide even light and optimum illumination. Including a permanently integrated LED lamp with a warm white colour temperature of 2700 K.

Two different mounting brackets are included, so that the luminaire can be attached to a mirror or a cabinet.

### Evie LED surface-mounted and mirror clip luminaire

Very wide light diffusion ensures optimal illumination of the mirror area.

The integrated LED lamp has a warm white colour temperature of 3000 K.

### Selo LED surface-mounted and mirror clip luminaire

Selo includes an integrated efficient LED lamp and is ideally designed for use on mirror cabinets or mirrors.

By touching the touch switch integrated on the bottom surface, the light colour can be continuously changed from the colour temperature 2700 K warm white to 6500 K daylight white (incl. memory function) thanks to Tunable White control technology.



Non-replaceable LED

230V

IP44

warm white

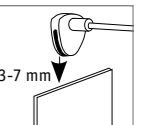

Mirror clip	Lumen	Watt	Kelvin	Dimensions	Material	Item
1 Double Hook	280 lm	3.2 W	2700 K	⇄300 ⇄80 ↗110 mm	metal	99385
2 Evie	610 lm	8 W	3000 K	⇄400 ⇄39 ↗105 mm	plastic	78938

Tunable White

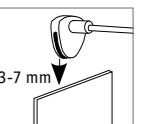

Mirror clip	Lumen	Watt	Kelvin	Dimensions	Material	Item
3 Selo	400 lm	3.7 W	2700–6500 K	⇄300 ⇄37 ↗150 mm	aluminium, acrylic	78950



### Simplo GU10 LED mirror luminaire

The Simplo mirror luminaire guarantees uniform illumination of mirror surfaces in the bathroom.

It is mounted directly on the mirror, and the spot head can be individually adjusted.

Including an integrated replaceable GU10 LED lamp with a warm white colour temperature of 2700 K.

### Becrux LED mirror luminaire

The Becrux mirror luminaire guarantees uniform illumination of bathroom mirror surfaces.

It is mounted directly on the mirror, and the spot head can be individually adjusted.

Including an integrated high-intensity LED lamp in a warm white colour temperature of 3000 K.

### Mintaka mirror luminaire

The Mintaka mirror luminaire guarantees uniform illumination of bathroom mirror surfaces.

It is mounted directly on the mirror, and the spot head can be individually adjusted.

The user can select their preferred lamp for individual design freedom. The luminaire is dimmable when a suitable lamp is used.

*Don't forget:* include a suitable dimmable lamp in your order!



Replaceable lamp | Recommended lamp 28410 metal | 230 V IP20

warm white

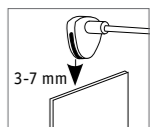

Mirror clip	Lumen	Watt	Kelvin	Dimensions	Item
1 Simplo	345 lm	5.3 W	2700 K	↔30 ↕60 ↗100 ø51 mm	BI 99905

Non-replaceable LED metal | 230 V IP20

warm white

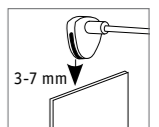

Mirror clip	Lumen	Watt	Kelvin	Dimensions	Item
2 Becrux	336 lm	4 W	3000 K	↔93 ↕93 ↗140 mm	c 70881

Replaceable lamp | Recommended lamp 28286 metal | 230 V IP20

Dimmable

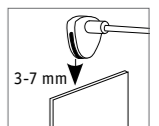

Mirror clip	Watt	Base	Dimensions	Item
3 Mintaka	max. 20 W	GU10	↔56 ↕38 ↗120 mm	c 70880



### Luno LED wall and mirror luminaire

With its integrated LED lamp and simple delicate design, Luno can be used in any bathroom as a wall or mirror luminaire.

White Switch control technology: by hovering a hand over the sensor integrated in the luminaire, the light colour can be changed from a 2700 K warm white colour temperature, to 4000 K neutral white, and up to 6500 K daylight white (incl. memory function).

### Tova LED wall and mirror luminaire

The delicate Tova LED luminaire can be used on walls, above or alongside mirrors in almost any bathroom.

Including a permanently integrated LED lamp and featuring Tunable White control technology.

The colour temperature can be controlled continuously from 2700 K warm white to 6500 K daylight white with the included remote control, or dimmed continuously within a white tone.

With night light and memory function.

### Wall and mirror luminaires

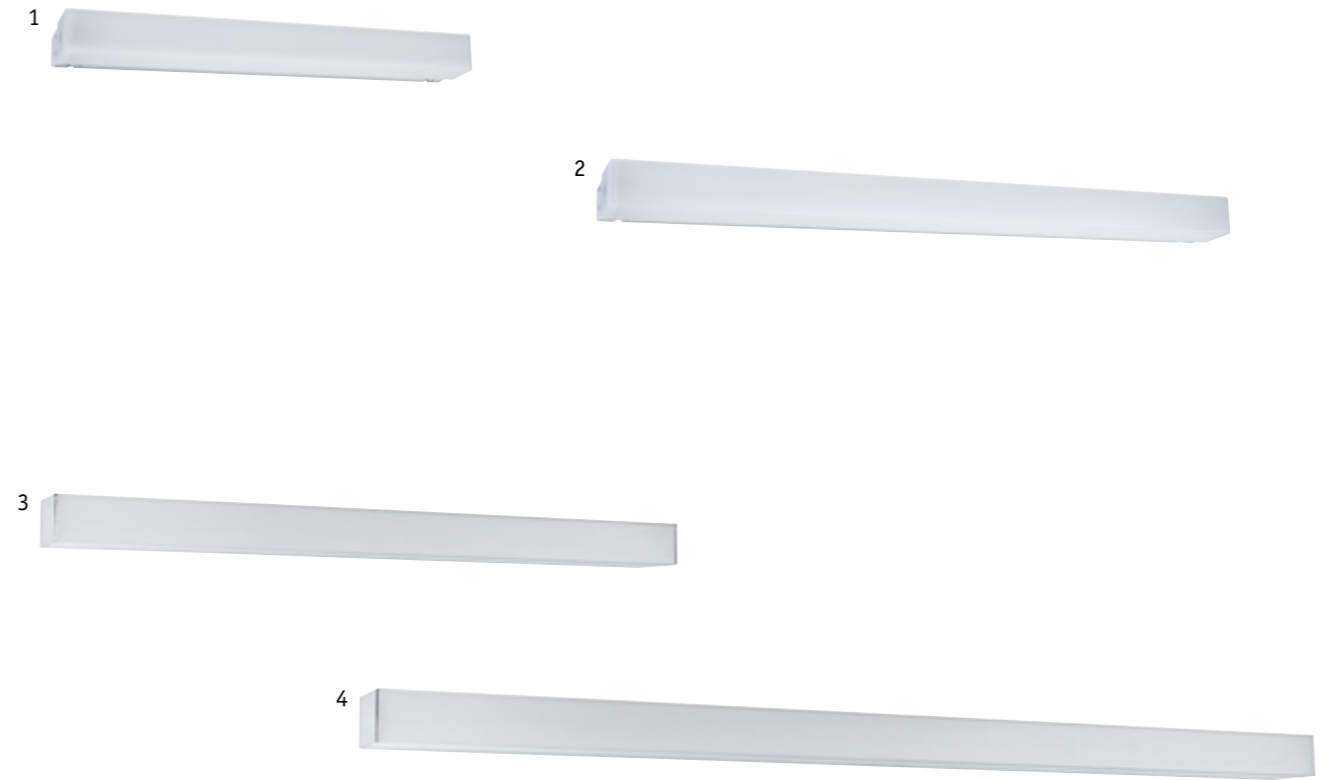

Non-replaceable LED

metal, plastic | 230 V

IP44

White Switch

Motion sensor

Luno	Lumen	Watt	Kelvin	Dimensions	Item
1 Wall and mirror luminaire with sensor	550 lm	6 W	2700–6500 K	⇄396 ⇄61 ⇄38	BA 78948
2 Wall and mirror luminaire with sensor	770 lm	8 W	2700–6500 K	⇄596 ⇄56 ⇄38	BA 78949

Non-replaceable LED

metal, acrylic | 230 V

IP44

Tunable White

Remote control

Dimmable

Tova	Lumen	Watt	Kelvin	Dimensions	Item
3 Wall and mirror luminaire	600 lm	6.2 W	2700–6500 K	⇄600 ⇄40 ⇄58	c 78944
4 Wall and mirror luminaire	800 lm	8.7 W	2700–6500 K	⇄900 ⇄40 ⇄58	c 78945



Wall and mirror luminaires



Non-replaceable LED

metal, acrylic | 230 V

IP44

warm white



**Nembus LED wall and mirror luminaire**

Nembus scores with timeless elegance and a clear design with harmoniously rounded end caps in chrome.

With integrated high-intensity LED lamp in a warm white colour temperature of 3000 K.



**Quasar LED wall and mirror luminaire**

Quasar is a design classic that suits a range of modern interiors and blends harmoniously and unobtrusively into the lighting design of virtually any bathroom.

Including an integrated LED lamp with a warm white colour temperature of 3000 K.

**Kuma LED wall and mirror luminaire**

The Kuma wall and mirror luminaire impresses with its chrome-plated glare shield. This makes it ideal for use above the mirror.

It comes complete with an integrated LED lamp in a warm white colour temperature of 3000 K.

	Wall and mirror luminaire	Lumen	Watt	Kelvin	Dimensions	Item
1	Nembus	600 lm	9 W	3000 K	⇄600 ⇄68 ⇄63 mm	<b>c</b> 70464
2	Quasar	835 lm	10.5 W	3000 K	⇄700 ⇄45 ⇄60 mm	<b>c</b> 79715
2	Quasar	570 lm	7.5 W	3000 K	⇄440 ⇄45 ⇄60 mm	<b>c</b> 79714
3	Kuma	660 lm	9 W	3000 K	⇄500 ⇄45 ⇄84 mm	<b>c</b> 70470



### Mizar LED wall and mirror luminaire

The clear lines and the harmoniously rounded end caps in chrome give the Mizar wall and mirror luminaire a timeless elegance.

With integrated LED lamp in a colour temperature of 3000 K (warm white).

### Orgon LED wall and mirror luminaire

The satined acrylic glass of the Orgon wall and mirror luminaire ensures fine light diffusion and uniform illumination.

With integrated coverable Schuko socket outlet.

It comes complete with an efficient integrated LED lamp in a warm white colour temperature of 3000 K.



Non-replaceable LED

metal, acrylic | 230V

IP44

warm white

Wall and mirror luminaire	Lumen	Watt	Kelvin	Dimensions	Item
1 Mizar	835 lm	10.5 W	3000 K	⇄630 ⇄45 ⇄82 mm	<b>c</b> 79716
2 Orgon with integrated socket	835 lm	10.5 W	3000 K	⇄700 ⇄60 ⇄82 mm	<b>c</b> 79713
2 Orgon with integrated socket	570 lm	7.5 W	3000 K	⇄440 ⇄60 ⇄82 mm	<b>c</b> 79712



### Lukida LED wall and mirror luminaire

The Lukida luminaire impresses with clear lines and glare-free room lighting.

Equipped with an integrated high-intensity LED lamp with a warm white colour temperature of 3000 K.

### Arneb LED wall and mirror luminaire

The Arneb wall and mirror luminaire features a simple design in different colours and finishes, and is ideal for use in bathrooms.

The luminaire comes integrated with the latest efficient LED technology.

The luminaires are optionally equipped with WhiteSwitch control technology. By pressing the existing standard light switch, the user can cycle through three white tones (warm white 3000 K, neutral white 4000 K, or daylight white 6500 K), so that the lighting can be customised to user requirements and the time of day (incl. memory function).

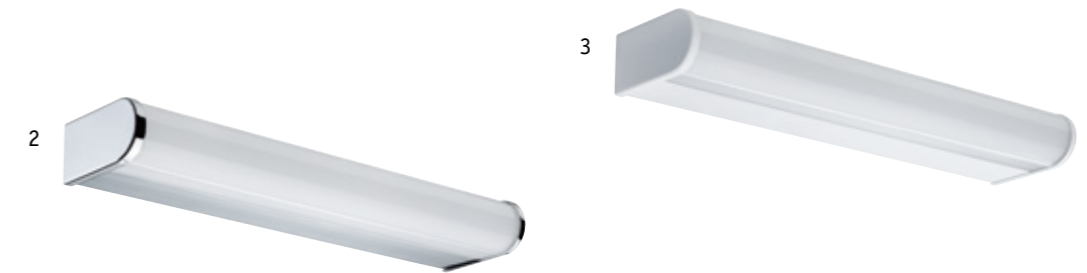

Non-replaceable LED

aluminium, acrylic | 230 V

IP44

warm white

Wall and mirror luminaire	Lumen	Watt	Kelvin	Dimensions	Item
1 Lukida	650 lm	9 W	3000 K	⇄600 ⇄100 ⇄42 mm	C 70463
2 Arneb	550 lm	9 W	3000 K	⇄326 ⇄40 ⇄78 mm	C 70879
3 Arneb	550 lm	9 W	3000 K	⇄326 ⇄40 ⇄78 mm	W 70878

White Switch

Wall and mirror luminaire	Lumen	Watt	Kelvin	Dimensions	Item
2 Arneb	700 lm	6.5 W	2700–6500 K	⇄328 ⇄40 ⇄78 mm	C 78943



Replaceable lamp

metal, glass | 230 V

IP44

● warm white | 
 ☾ Dimmable



### Lenia LED wall and mirror luminaire

Lenia's understated shape and its lightweight base make this two-lamp mirror luminaire a very popular lighting solution for any bathroom.

### Carina/ Eleon wall luminaire

The wall luminaires Carina and Eleon with satined glass shade provide uniform and pleasant room lighting.

### Gemini LED wall and mirror luminaire 2-piece set

Basic cubic shapes and solid holders give the wall and mirror luminaire Gemini its unmistakable character. The 2-piece set contains a right-hand and left-hand mirror luminaire.

The user can select their preferred lamp for all luminaires, allowing individual design freedom. The luminaire is dimmable and even smart controllable when a suitable lamp is used.

*Don't forget:* include a suitable dimmable lamp with an E14 base in your order!

Wall and mirror luminaire	Watt	Base	⚡	Dimensions	Item
1 Lenia	max. 2x 20 W	E14	28572	↔80 ↕330 ↗105 mm	<b>C</b> 70350
2 Carina	max. 28 W	G9	28796	↔105 ↕157 ↗115 mm	<b>CM</b> 70838
3 Eleon	max. 33 W	G9	28796	↔105 ↕203 ↗135 mm	<b>C</b> 70839
4 Gemini	max. 2x 20 W	E14	28572	↔85 ↕195 ↗105 mm	<b>C</b> 70354





### Agena LED wall and mirror luminaire

The extraordinary Agena accentuates any wall with decorative, indirect lighting effects.

It is ideal for uniform illumination of mirrors.

The light fixture comes with a very bright integrated LED lamp in a warm white colour temperature of 2700 K.

The luminaire can be dimmed with a standard dimmer.

### Lucille LED wall washer

The Lucille swivelling wall washer creates unique lighting effects on the wall.

As indirect auxiliary lighting in large home bathrooms, as eye-catching and atmospheric zone light or as mirror lighting: the modern, linear design suits every interior style.

The lighting effects can be individually adjusted by swivelling the aluminium shade. Alignment enables direct or indirect lighting.

Integrated 3-step dimmer function: pressing a standard light switch cycles the luminaire through three different dimming levels. The memory function stores the most recently used setting until the light is next switched on.



Non-replaceable LED

aluminium | 230 V

IP44

warm white | Dimmable

Agena	Lumen	Watt	Kelvin	Dimensions	Item
1 Wall and mirror luminaire	1200 lm	20 W	2700 K	⇄310 ⇄50 ⇄125 mm	<b>C</b> 70948

warm white | 3-step dim

Lucille	Lumen	Watt	Kelvin	Dimensions	Item
2 Wall and mirror luminaire	1000 lm	11.5 W	2700 K	⇄400 ⇄50 ⇄100 mm	<b>W</b> 79515
3 Wall and mirror luminaire	1600 lm	18 W	2700 K	⇄600 ⇄50 ⇄100 mm	<b>W</b> 79516



### Sabik LED wall and mirror luminaire

The decorative lighting effects of the Sabik wall luminaire radiate upwards and downwards, accentuating any wall. A dichroic foil for coloured spectral lighting effects is included.

The permanently integrated warm white LED lamp has a warm white colour temperature of 2700 K.

The luminaires can be dimmed continuously with a standard dimmer to create the perfect mood lighting.



Non-replaceable LED

plastic | 230 V IP44

warm white | Dimmable

Sabik	Lumen	Watt	Kelvin	Dimensions	Item
1 Wall and mirror luminaire	570/360 lm	9 W	2700 K	⇄117 ⇄80 ⇄152 mm	<b>C</b> 70947
2 Wall and mirror luminaire	570/360 lm	9 W	2700 K	⇄117 ⇄80 ⇄152 mm	<b>B</b> 79769
3 Wall and mirror luminaire	570/360 lm	9 W	2700 K	⇄117 ⇄80 ⇄152 mm	<b>W</b> 70946

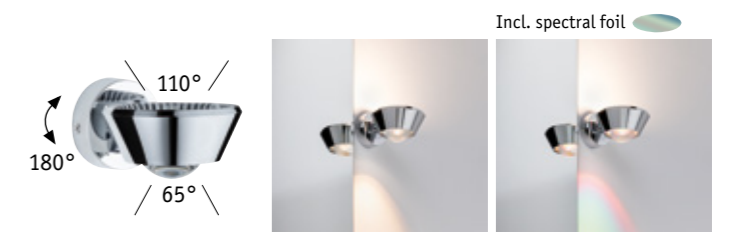



### Flame LED wall luminaire

The Flame surface-mounted wall luminaire comes in a range of variants in matt white or anthracite, and is specially designed for wall mounting. It creates attractive lighting effects upwards or downwards, or optionally in both directions.

It is exceptionally robust thanks to the durable aluminium housing, as well as being low maintenance and long-lasting thanks to efficient LED technology.

It comes complete with an efficient integrated LED lamp in a warm white colour temperature of 3000 K.



💡 Non-replaceable LED

🏠 aluminium | 230 V

🛡️ IP44

🟡 warm white

Wall luminaire	Lumen	Watt	Kelvin	Dimensions	Item
1 Flame	320 lm	3.8 W	3000 K	⇄58 ⇄103 ⇄75 mm	W 94329
2 Flame	320 lm	3.8 W	3000 K	⇄58 ⇄103 ⇄75 mm	DG 94327
3 Flame	260 lm	3.5 W	3000 K	⇄58 ⇄128 ⇄75 mm	W 94330
4 Flame	260 lm	3.5 W	3000 K	⇄58 ⇄128 ⇄75 mm	DG 94328
5 Flame	290 lm	2.8 W	3000 K	⇄65 ⇄155 ⇄70 mm	DG 94326
6 Flame	540 lm	5.8 W	3000 K	⇄102 ⇄220 ⇄100 mm	DG 94325



## Cybo LED wall luminaire

The Cybo wall luminaire is available in different versions in matt white or grey, creating attractive light accents on walls, to ensure perfect orientation in the bathroom.

Light can be emitted upwards or downwards. The rotatable light module enables the user to individually control light deflection.

It comes complete with an efficient integrated LED lamp in a warm white colour temperature of 3000 K.

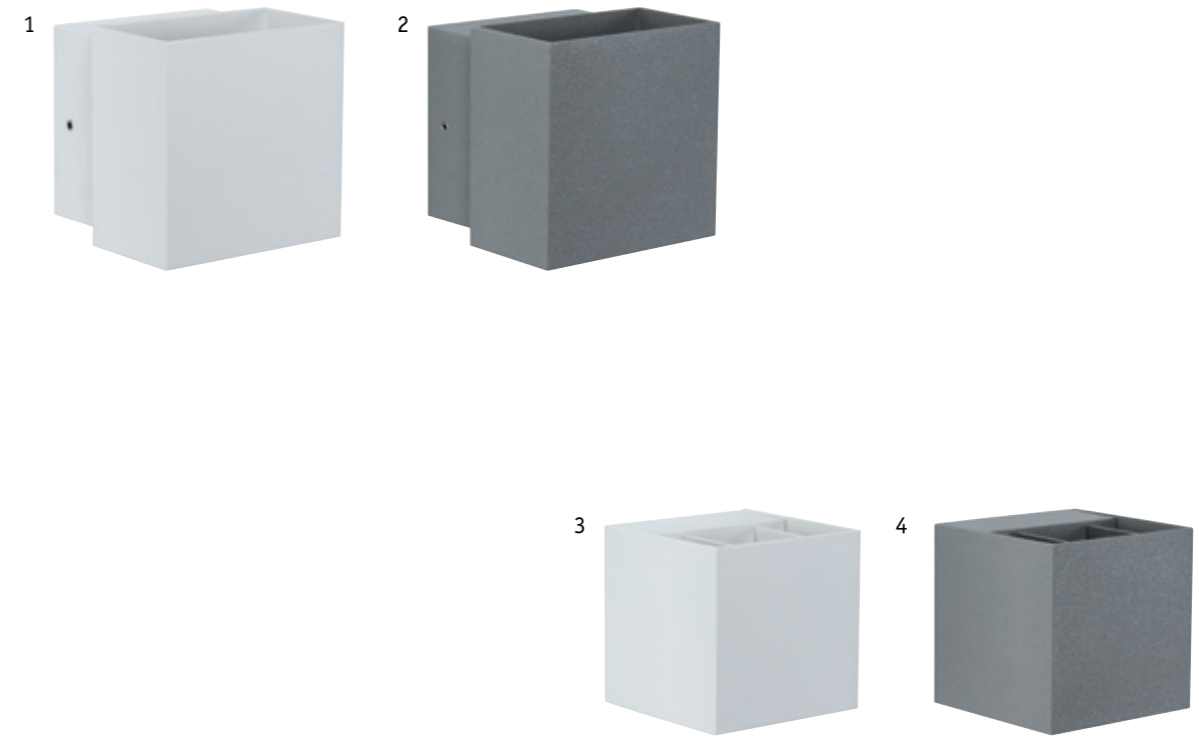

💡 Non-replaceable LED

📏 aluminium | 230 V

🛡️ IP65

🟡 warm white

Cybo	Lumen	Watt	Kelvin	Dimensions	Item
1 Rotating wall luminaire	200 lm	3.5 W	2700 K	⇄100 ⇄93 ⇄100 mm	W 18003
2 Rotating wall luminaire	200 lm	3.5 W	2700 K	⇄100 ⇄93 ⇄100 mm	G 18002
3 Wall luminaire with flexible beam angle	213 lm	3.5 W	2700 K	⇄80 ⇄80 ⇄80 mm	W 18001
4 Wall luminaire with flexible beam angle	213 lm	3.5 W	2700 K	⇄80 ⇄80 ⇄80 mm	G 18000

Rotating wall luminaire



Flexible beam angle

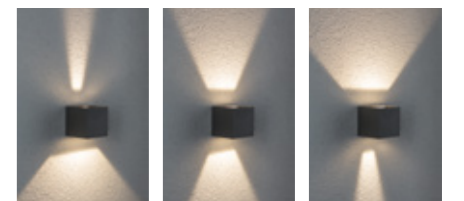



### MaxLED 250 LED strips

For decorative light accents in the bathroom

- Complete set of LED strips including power supply and extension strips
- Simple plug-in system for easy installation
- Can be shortened as required (167 mm)
- Self-adhesive backing for easy mounting
- Flexible material for mounting on flat or curved surfaces
- Includes 5-pin plug for easy connection of the strips
- IP protection: IP44 with protective cover – splash-protected
- 30 LED/m

### LED strips

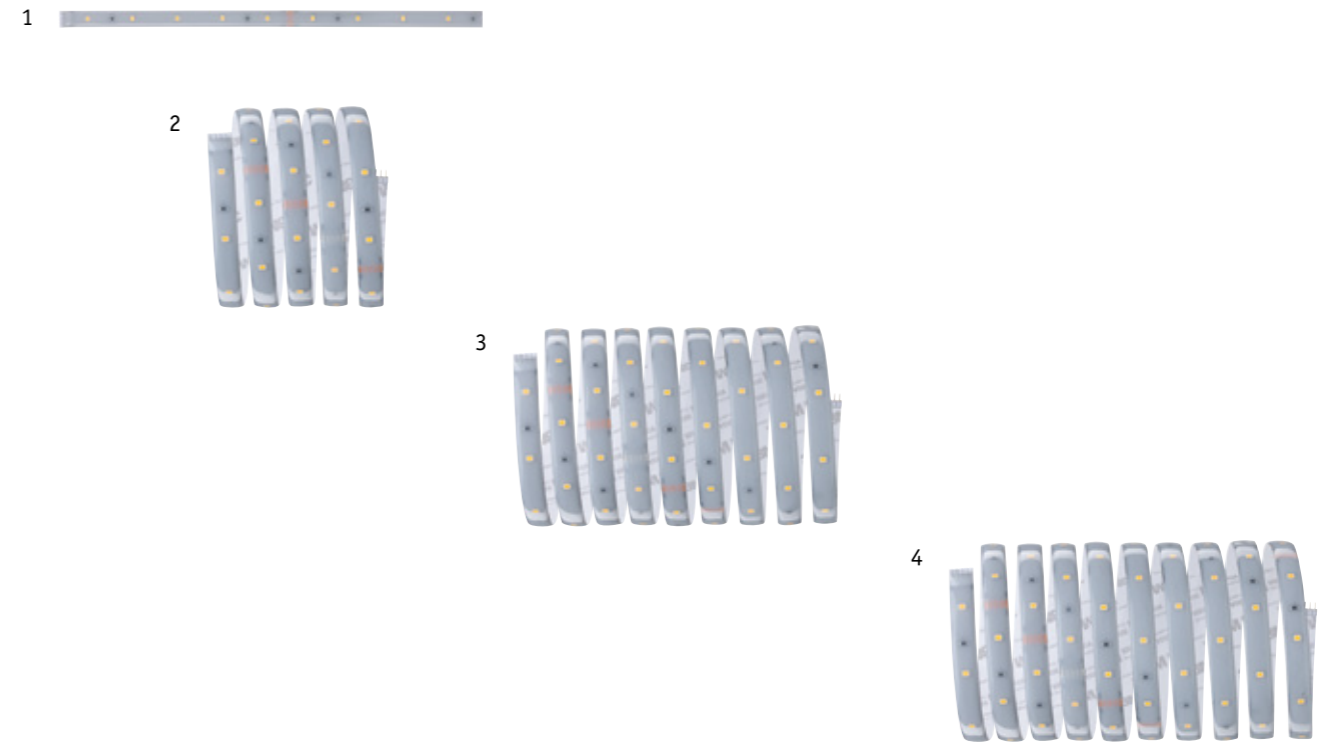

💡 Non-replaceable LED | Recommended accessories on page 107

📏 plastic | 230 V

🛡️ IP44

🟡 warm white | ⏸️ Dimmable

	MaxLED 250	Lumen	Watt	Kelvin	Dimensions	Item
1	Strip 1 m	240 lm	4 W	2700 K	⇄1 m ⇄3 ⇄12.5 mm	79870
2	Basic Set (1.5 m strip and 24 VA transformer)	360 lm	6 W	2700 K	⇄1.5 m ⇄3 ⇄12.5 mm	79868
3	Strip 2.5 m	600 lm	10 W	2700 K	⇄2.5 m ⇄3 ⇄12.5 mm	79871
4	Basic Set (3 m strip and 24 VA transformer)	720 lm	12 W	2700 K	⇄3 m ⇄3 ⇄12.5 mm	79869

🌈 Tunable White | ⏸️ Dimmable

	MaxLED 250	Lumen	Watt	Kelvin	Dimensions	Item
1	Strip 1 m	230 lm	4 W	2700–6500 K	⇄1 m ⇄3 ⇄12.5 mm	79878
2	Basic Set (1.5 m strip and 24 VA transformer)	345 lm	5.5 W	2700–6500 K	⇄1.5 m ⇄3 ⇄12.5 mm	79876
3	Strip 2.5 m	575 lm	9 W	2700–6500 K	⇄2.5 m ⇄3 ⇄12.5 mm	79879
4	Basic Set (3 m strip and 24 VA transformer)	690 lm	11 W	2700–6500 K	⇄3 m ⇄3 ⇄12.5 mm	79877

🌈 RGBW | 🌈 Tunable White | ⏸️ Dimmable

	MaxLED 250	Lumen	Watt	Kelvin	Dimensions	Item
1	Strip 1 m	230 lm	7 W	W=3000 K	⇄1 m ⇄3 ⇄12.5 mm	79882
2	Basic Set (1.5 m strip and 24 VA transformer)	345 lm	10 W	W=3000 K	⇄1.5 m ⇄3 ⇄12.5 mm	79880
3	Strip 2.5 m	575 lm	17 W	W=3000 K	⇄2.5 m ⇄3 ⇄12.5 mm	79883
4	Basic Set (3 m strip and 24 VA transformer)	690 lm	20 W	W=3000 K	⇄3 m ⇄3 ⇄12.5 mm	79881



### MaxLED 500 LED strips

#### Basic lighting in the bathroom

- Complete set of LED strips including power supply and remote control
- Simple plug-in system for easy installation
- Can be shortened as required (83 mm)
- Self-adhesive backing for easy mounting
- Flexible material for mounting on flat or curved surfaces
- Includes 5-pin plug for easy connection of the strips
- IP protection: IP44 with protective cover – splash-protected

### LED strips



💡 Non-replaceable LED | Recommended accessories on page 107

📏 plastic | 230 V

🛡️ IP44

🟡 warm white | ⏸️ Dimmable

	MaxLED 500	Lumen	Watt	Kelvin	Dimensions	Item
1	Strip 1 m	440 lm	6 W	2700 K	⇄1 m ⇄4 ⇄12.5 mm	70663
2	Basic Set (1.5 m strip and 24 VA transformer)	660 lm	9 W	2700 K	⇄1.5 m ⇄4 ⇄12.5 mm	70668
3	Strip 2.5 m	1100 lm	15 W	2700 K	⇄2.5 m ⇄4 ⇄12.5 mm	70549
4	Basic Set (3 m strip and 24 VA transformer)	1320 lm	18 W	2700 K	⇄3 m ⇄4 ⇄12.5 mm	70666

🌈 Tunable White | ⏸️ Dimmable

	MaxLED 500	Lumen	Watt	Kelvin	Dimensions	Item
1	Strip 1 m	470 lm	7 W	2700–6500 K	⇄1 m ⇄3 ⇄12.5 mm	70630
2	Basic Set (1.5 m strip and 24 VA transformer)	705 lm	10 W	2700–6500 K	⇄1.5 m ⇄3 ⇄12.5 mm	70623
3	Strip 2.5 m	1175 lm	16 W	2700–6500 K	⇄2.5 m ⇄3 ⇄12.5 mm	70550
4	Basic Set (3 m strip and 24 VA transformer)	1410 lm	20 W	2700–6500 K	⇄3 m ⇄3 ⇄12.5 mm	70624

🌈 RGBW | 🌈 Tunable White | ⏸️ Dimmable

	MaxLED 500	Lumen	Watt	Kelvin	Dimensions	Item
1	Strip 1 m	440 lm	12 W	W=3000 K	⇄1 m ⇄3 ⇄12.5 mm	70634
2	Basic Set (1.5 m strip and 24 VA transformer)	660 lm	18 W	W=3000 K	⇄1.5 m ⇄3 ⇄12.5 mm	70627
3	Strip 2.5 m	1100 lm	30 W	W=3000 K	⇄2.5 m ⇄3 ⇄12.5 mm	70551
4	Basic Set (3 m strip and 24 VA transformer)	1320 lm	36 W	W=3000 K	⇄3 m ⇄3 ⇄12.5 mm	70628



## MaxLED 1000 LED strips

For bright basic lighting in the bathroom

- Complete set of LED strips including power supply
- Simple plug-in system for easy installation
- Colour temperature: 2700 K – warm white
- Can be shortened as required
- Self-adhesive backing for easy mounting
- Flexible material for mounting on flat or curved surfaces
- Includes 5-pin plug for easy connection of the strips
- IP protection: IP44 with protective cover – splash-protected

## LED strips

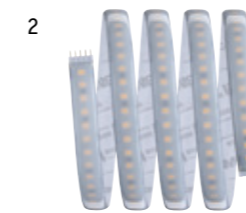

Non-replaceable LED | Recommended accessories on page 107

plastic | 230 V

IP44

warm white | Dimmable







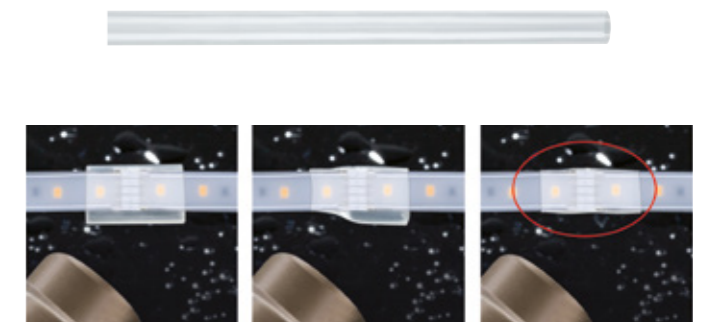



	MaxLED 1000	Lumen	Watt	Kelvin	Dimensions	Item
1	Strip 1 m	880 lm	12 W	2700 K	⇄1 m ⇄4 ⇄12.5 mm	70676
2	Basic Set (1.5 m strip and 24 VA transformer)	1320 lm	18 W	2700 K	⇄1.5 m ⇄4 ⇄12.5 mm	70672
3	Strip 2.5 m	2200 lm	29 W	2700 K	⇄2.5 m ⇄4 ⇄12.5 mm	70552
4	Basic Set (3 m strip and 24 VA transformer)	2640 lm	35 W	2700 K	⇄3 m ⇄4 ⇄12.5 mm	70670

## Universal LED water protection

- The universal water-protection connector for LED strips is a heat shrink tube that protects coated LED strips from splashing water. It is compatible with all Paulmann LED MaxLED strips.
- The high shrinking capacity ensures reliable protection from strip to strip and at connection points between strips and plug contacts.
- On the inside, the connector is equipped with hot-melt adhesive.
- The connector can be shortened as required.





### Light characteristics



Lumen (lm)	Lumen (lm) is the unit of measure for luminous flux. Luminous flux is the total amount of light emitted by the lamp.
Watt (W)	Physical unit of output.
Kelvin (K)	The light colour of a lamp is described by the term "colour temperature". The unit of measure for colour temperature is Kelvin (K).
Warm white	Warm white light (between 2700 and 3000 Kelvin): warm white light is similar to natural light at sunset. The redder the light, the more relaxing it feels.
Neutral white	Neutral white light (between 3300 and 5300 Kelvin): this type of light creates "functional" lighting. A great choice for the kitchen or bathroom.
Dimmable	Continuously variable dimming without changing the light colour.
3-step dim	3-step dimming: pressing a standard light switch cycles through the three dimming levels.
WhiteSwitch	Pressing an existing standard light switch cycles through three different white tones (warm white, neutral white or daylight white).
Tunable White	Infinite selection of white light colour and brightness in the range between warm white and daylight white.
RGBW	Stepless selection from 16 million colour shades, additionally with real warm white, stepless dimming
Zigbee	ZigBee 3.0 allows luminaires to be controlled using app, voice or remote control.
	certified product
	Non-replaceable LED
	Replaceable lamp
	Replaceable coin
	Recommended lamp
	Heating function
	Bayonet glass
	Motion sensor
	Remote control
	Material

### Colour code

- BA** Aluminium
- C** Chrome
- CM** Chrome matt
- DG** Dark grey/anthracite
- BI** Brushed iron
- AU** Gold
- G** Grey
- WD** Wood look
- SA** Satin
- B** Black
- BC** Black chrome
- AG** Silver
- FB** Beige fabric
- FG** Grey fabric
- W** White

### Quality & safety

**IP protection classes**  
 

**Protection class**  
 

**DIALux**

**5-year warranty**  

**IP44 splash protection & IP65 water jet protection for direct water jets (\*and 12V/24V safety extra-low voltage)**

**Classification of the protection against electrical shock. The protection classes are I, II and III. Protection class I features a grounding wire (cable identification green/yellow). The double insulation of protection class II is used in connection with Euro plugs without grounding wire. Protection class III defines devices operated with low-voltage protectors.**

**All bathroom luminaires in this catalogue are stored in Dial's professional DialLux lighting design range**

**In addition to statutory warranty rights, Paulmann Licht GmbH also offers a warranty on the correct function of products from the Paulmann brand for a period of 5 years after purchase, subject to proper use and an average on-time of max. 4,500 h/year after professional installation.**

**You can find the complete warranty conditions at [www.paulmann.com/warranty](http://www.paulmann.com/warranty)**

All illustrations and information regarding dimensions, colour, etc. are subject to possible production tolerances and are non-binding. We reserve the right to make changes to products at any time.

### Shown shortened

≈ = All luminaires shown with this symbol are depicted in a shortened form. In reality, the cables are longer.



### Dimensioning of items

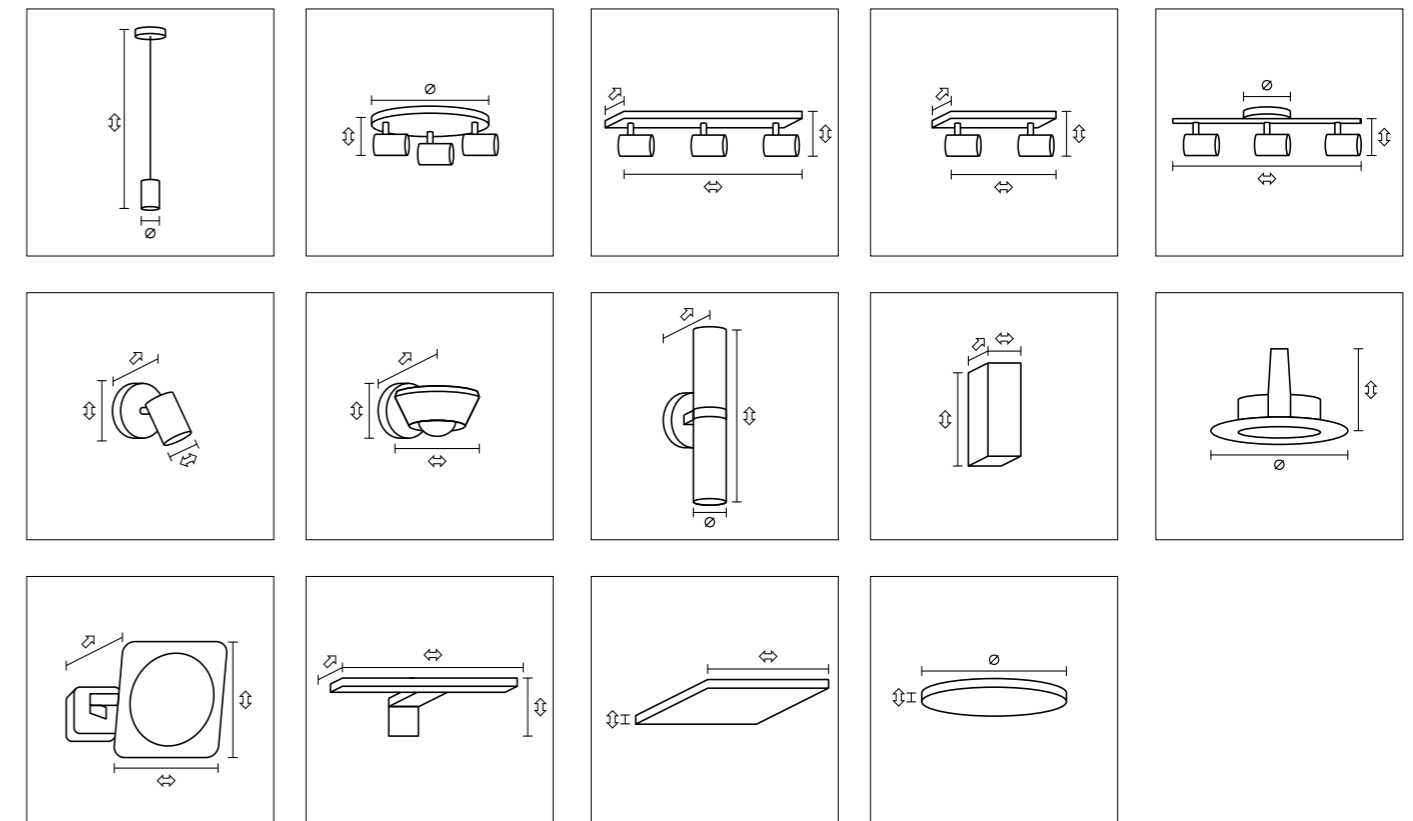

### Lamp range

A variety of shapes & technologies

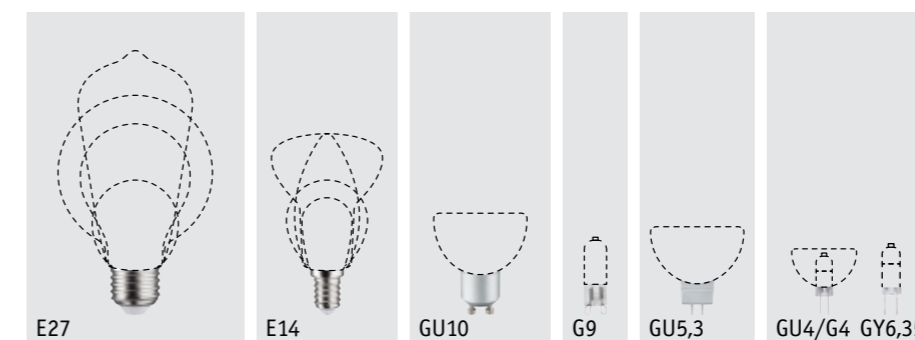

Choosing the right lamps to illuminate your home couldn't be more important. Important aspects that should be taken into account when planning lighting include the base, the design, the brightness in lumens, and dimmability. Paulmann offers an attractive selection of lamps for every application.



### Smart Home

Lighting control via app, voice command or remote control

The Zigbee wireless standard allows you to control your lighting system via the smik gateway, or a gateway with Zigbee 3.0 interface (e.g. Amazon Echo or Philips Hue Bridge 2). Paulmann offers the biggest single-source selection of smart luminaires, lighting systems, lamps, and accessories.



# P

**Paulmann**

**You will find more items in our brochures:**



**Pro Strips – Professional quality  
24V LED strip range for indoor use**

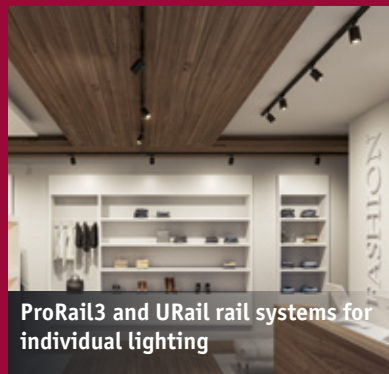

**ProRail3 and URail rail systems for  
individual lighting**

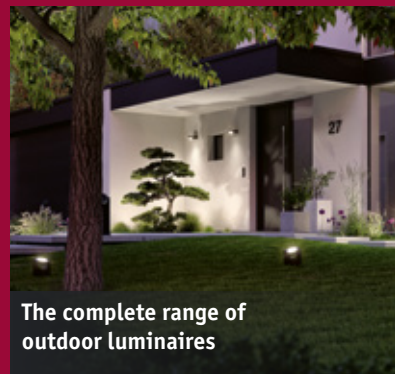

**The complete range of  
outdoor luminaires**

**Contact Germany**

Paulmann Licht GmbH  
Quezinger Feld 2  
31832 Springe Völksen  
Phone: +49 5041 998 317  
fachvertrieb@paulmann.de